

# Power and Ground Distribution: Electrical Diagrams

## Ground Distribution

### G100

**PLEASE NOTE:** Some diagrams may appear to be missing because of gaps in the number sequences. These "gaps" are actually for diagrams that do not apply to the vehicle model selected.

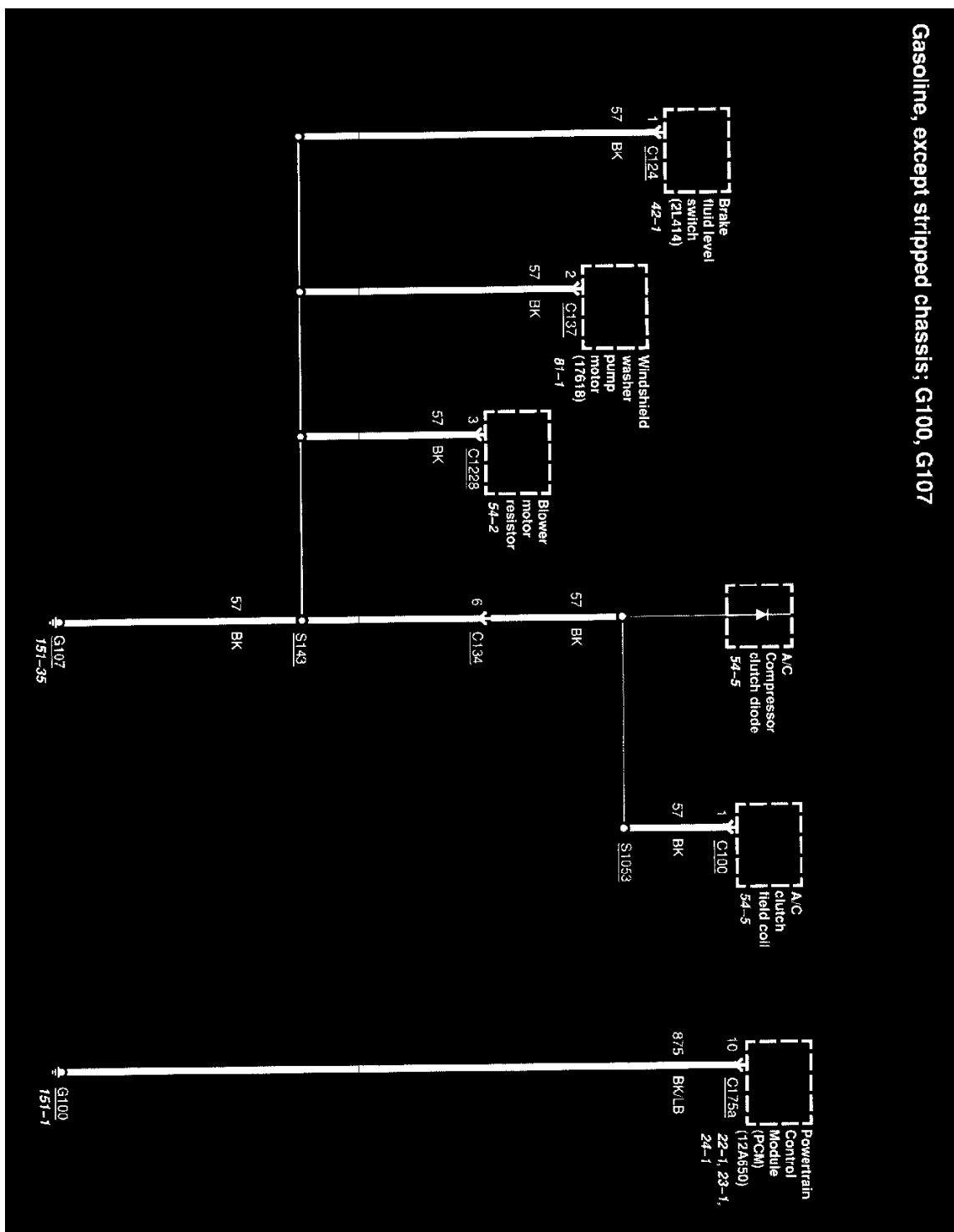

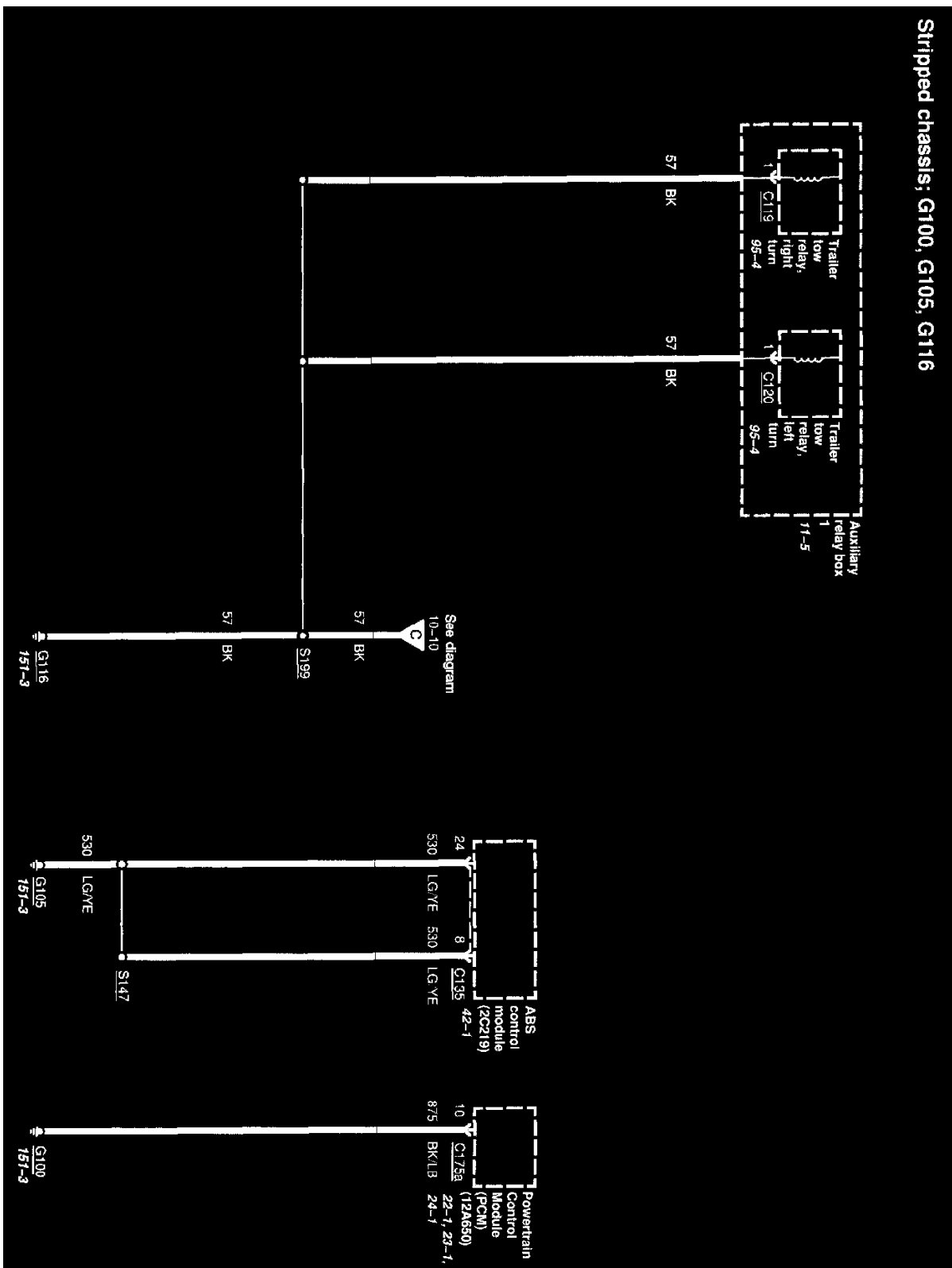

10-9

**Diagrams:** Other diagrams referred to by number (See Diagram #-#, etc.) within these diagrams can be found at **Diagrams By Number**. See: Diagrams/Electrical Diagrams/Diagrams By Number

**Locations:** Location Views (reference numbers starting with 151-) referred to within these diagrams can be found at **Component Location Views**. See: Diagrams/Components/Component Location Views

**G101**

**PLEASE NOTE:** Some diagrams may appear to be missing because of gaps in the number sequences. These "gaps" are actually for diagrams that do not apply to the vehicle model selected.

Gasoline, except stripped chassis: G101, G105

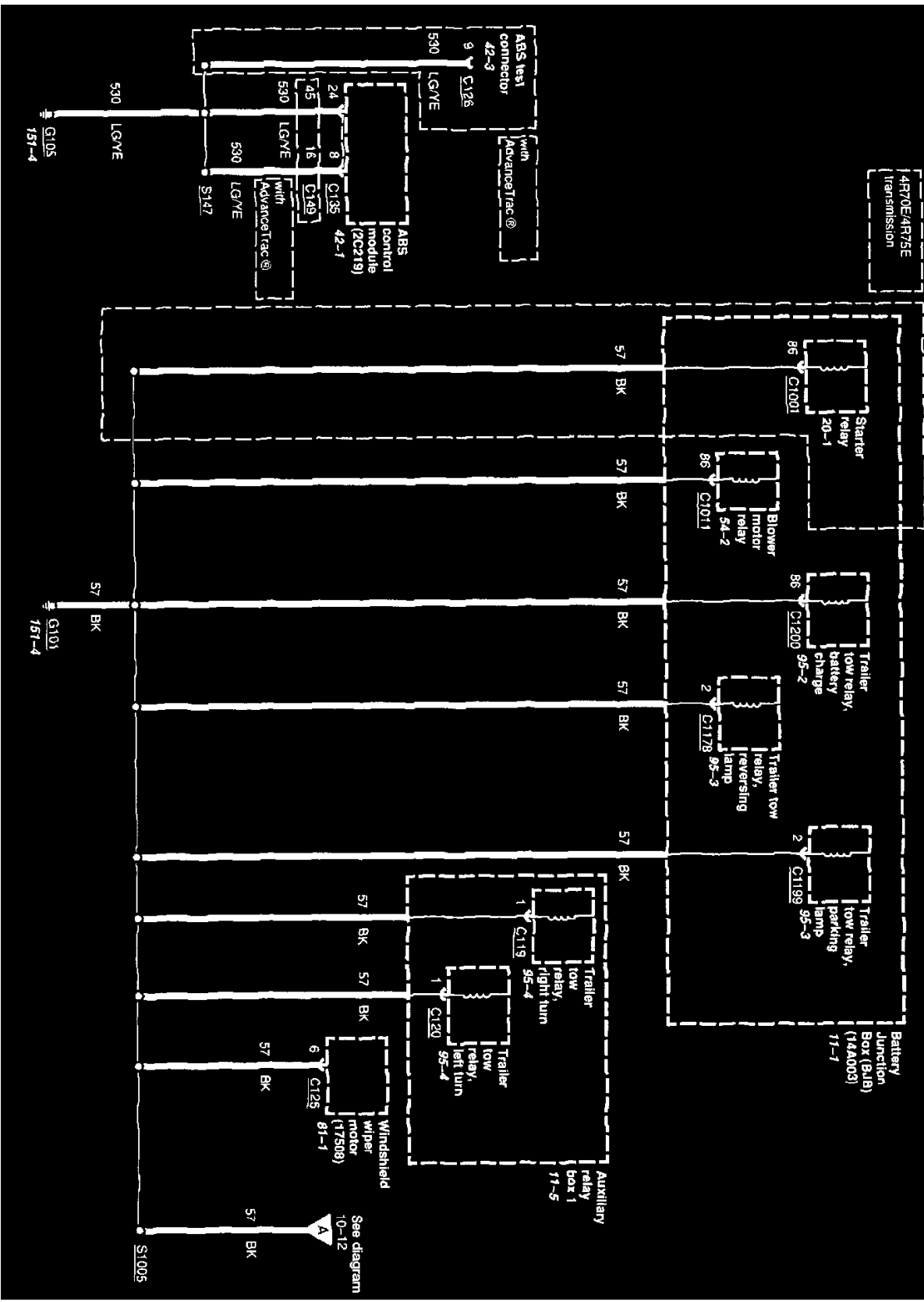



Except stripped chassis; G102, G103

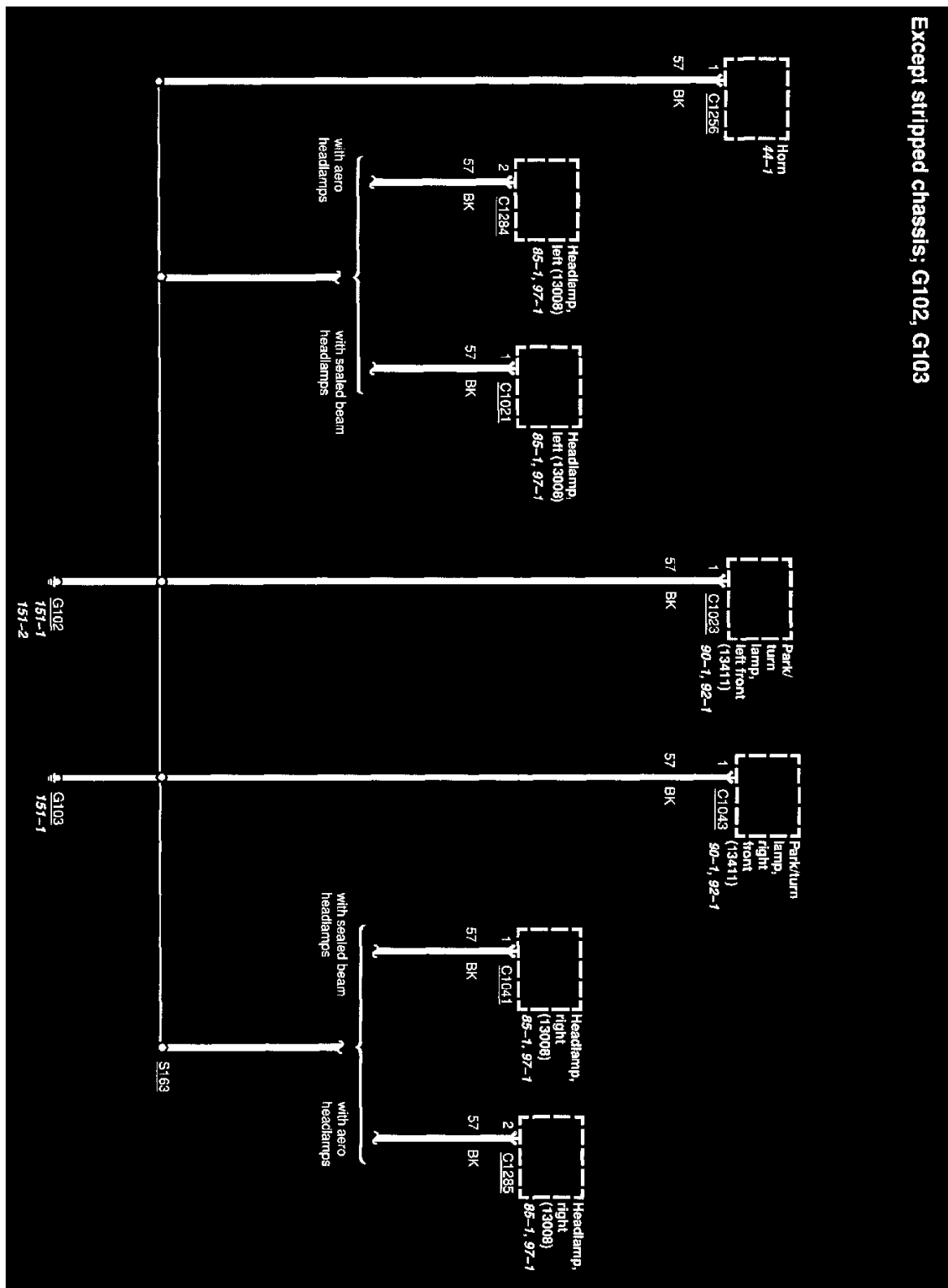

10-2

**Diagrams:** Other diagrams referred to by number (See Diagram #-#, etc.) within these diagrams can be found at **Diagrams By Number**. See: Diagrams/Electrical Diagrams/Diagrams By Number

**Locations:** Location Views (reference numbers starting with 151-) referred to within these diagrams can be found at **Component Location Views**. See: Diagrams/Components/Component Location Views

**G103**

**PLEASE NOTE:** Some diagrams may appear to be missing because of gaps in the number sequences. These "gaps" are actually for diagrams that do not apply to the vehicle model selected.

Except stripped chassis; G102, G103

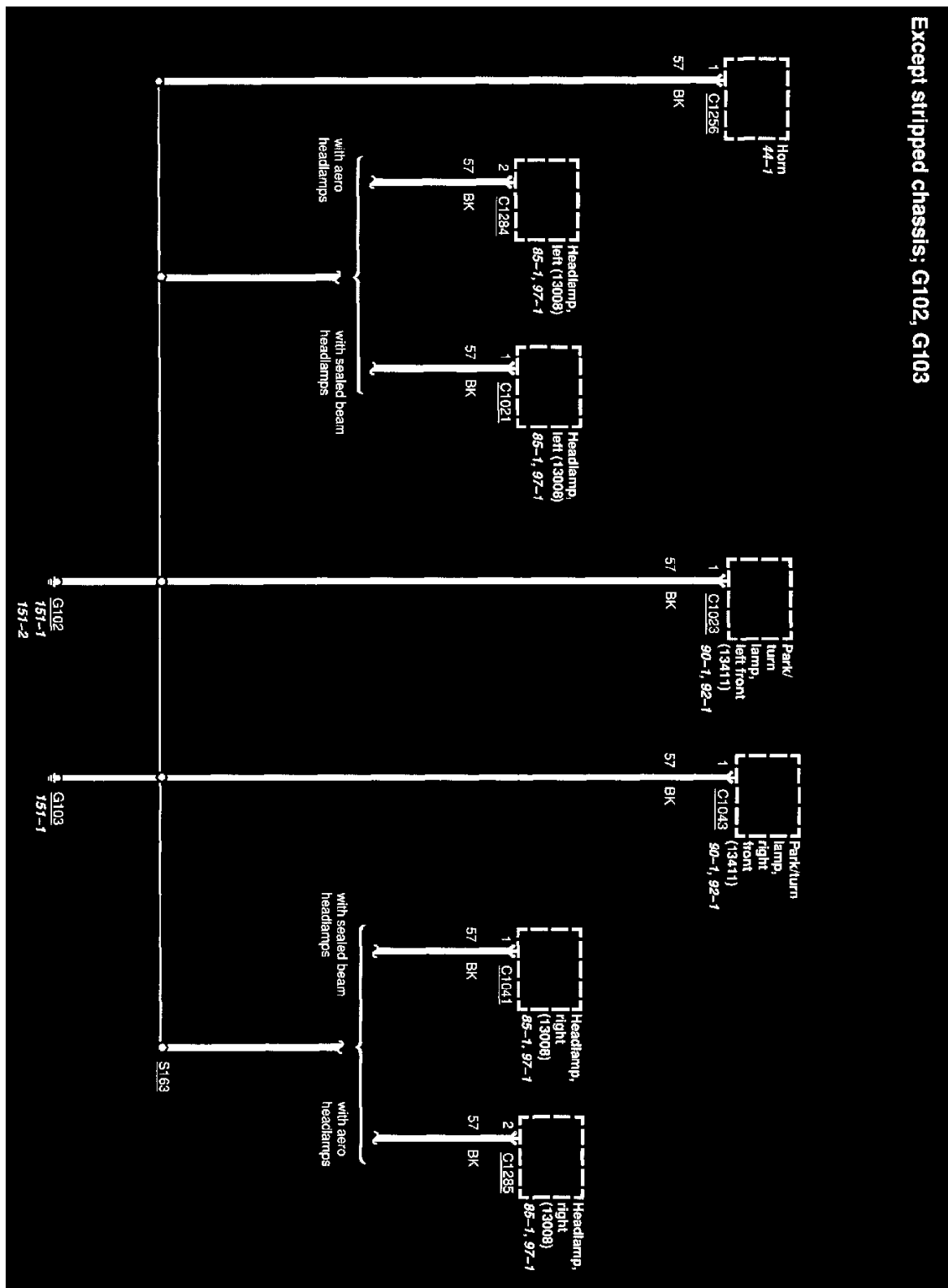

10-2

**Diagrams:** Other diagrams referred to by number (See Diagram #-#, etc.) within these diagrams can be found at **Diagrams By Number**. See: Diagrams/Electrical Diagrams/Diagrams By Number

**Locations:** Location Views (reference numbers starting with 151-) referred to within these diagrams can be found at **Component Location Views**. See: Diagrams/Components/Component Location Views

**G104**

**PLEASE NOTE:** Some diagrams may appear to be missing because of gaps in the number sequences. These "gaps" are actually for diagrams that do not apply to the vehicle model selected.



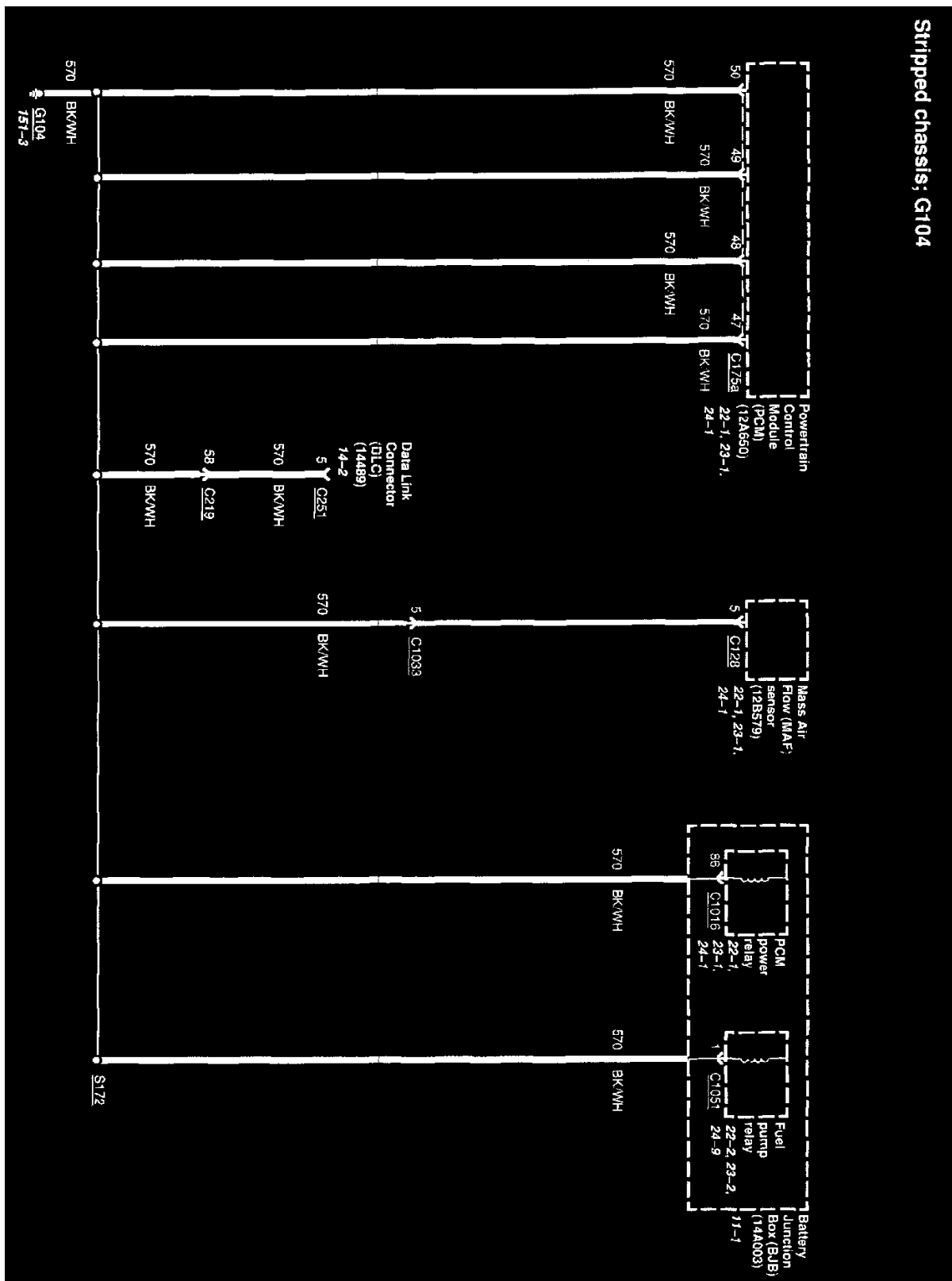

**Diagrams:** Other diagrams referred to by number (See Diagram #-#, etc.) within these diagrams can be found at **Diagrams By Number**. See: Diagrams/Electrical Diagrams/Diagrams By Number

**Locations:** Location Views (reference numbers starting with 151-) referred to within these diagrams can be found at **Component Location Views**. See: Diagrams/Components/Component Location Views

**G105**

**PLEASE NOTE:** Some diagrams may appear to be missing because of gaps in the number sequences. These "gaps" are actually for diagrams that do not apply to the vehicle model selected.



Striped chassis; G100, G105, G116

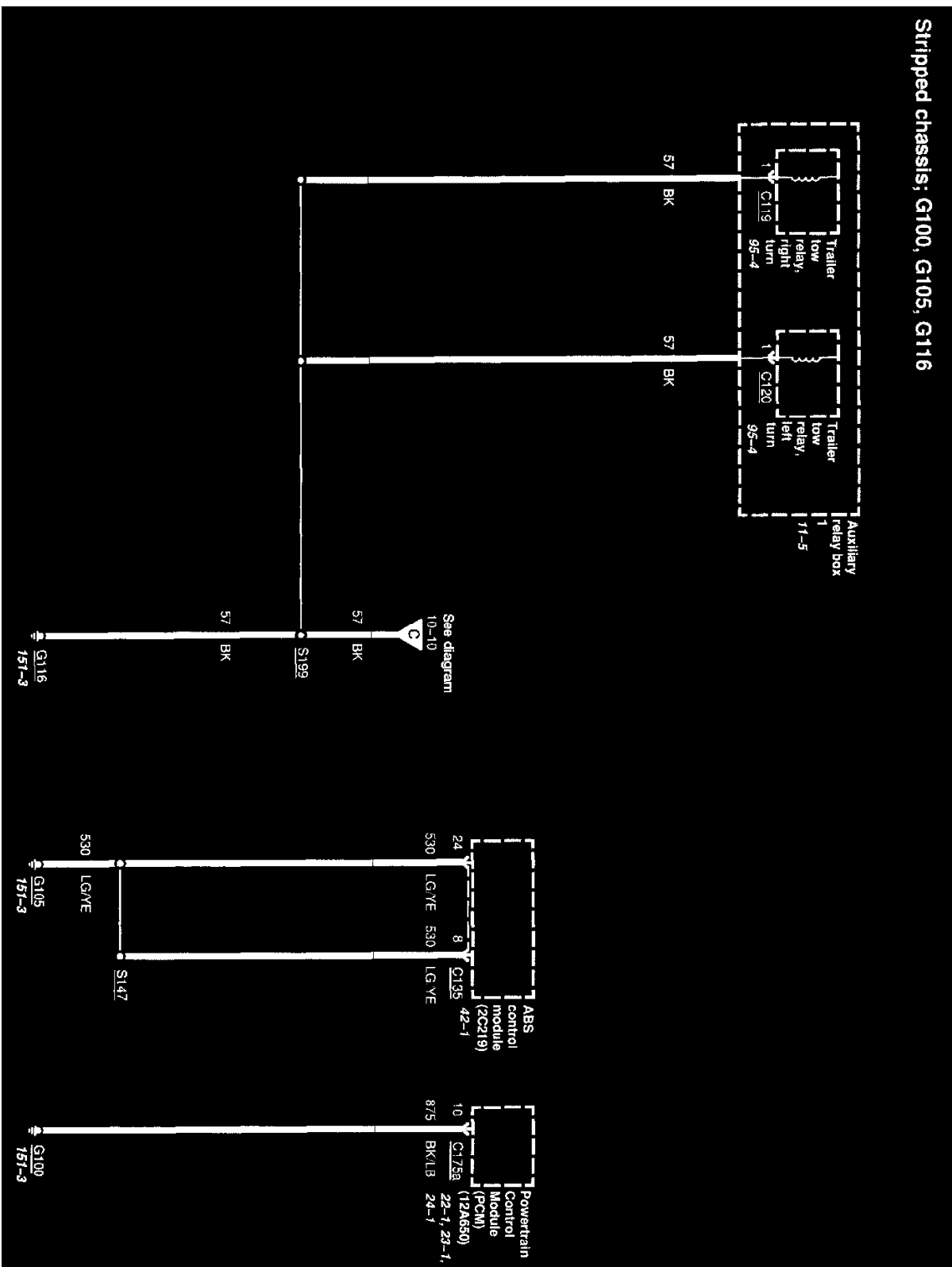



Gasoline, except stripped chassis; G100, G107

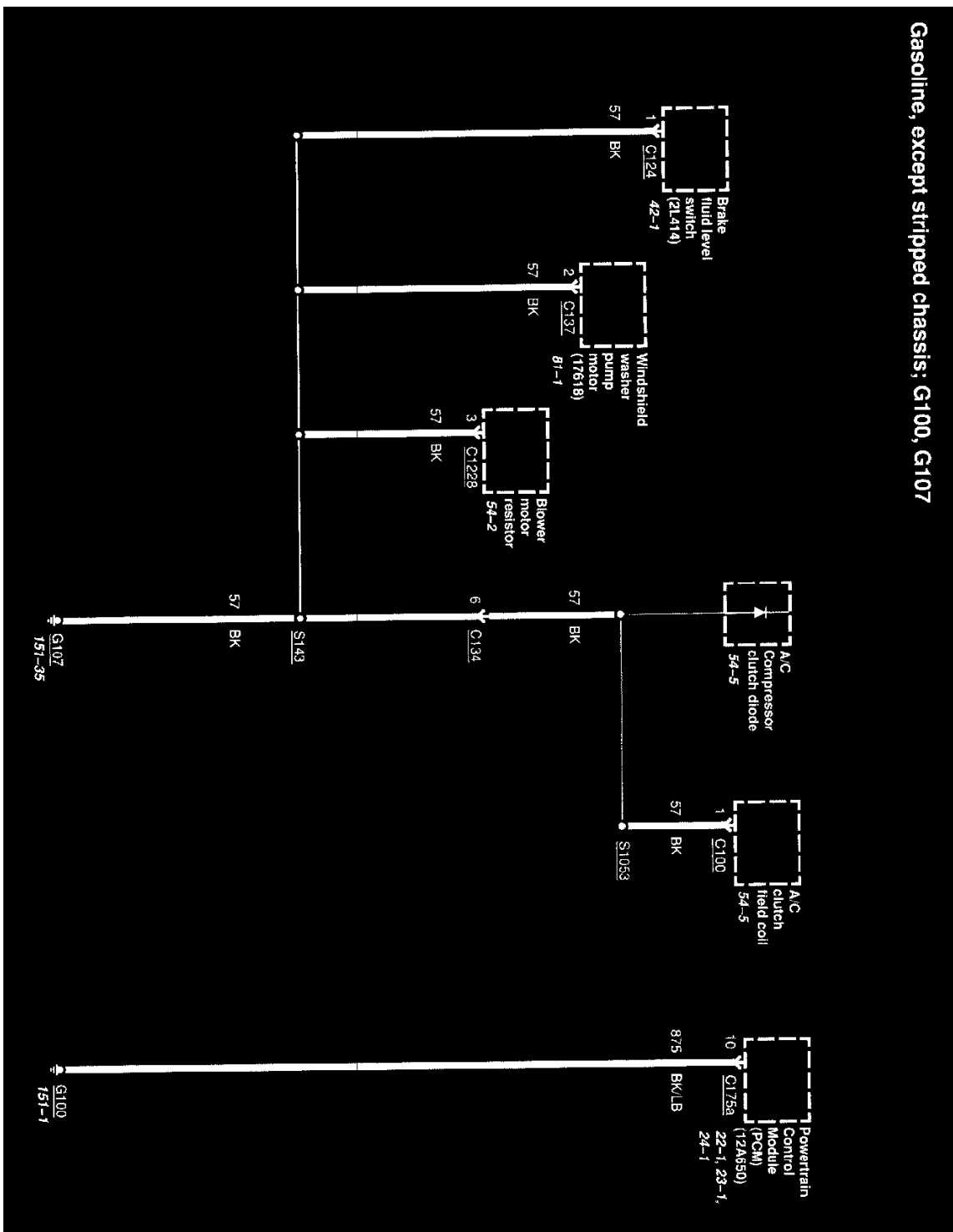

**Diagrams:** Other diagrams referred to by number (See Diagram #-#, etc.) within these diagrams can be found at **Diagrams By Number**. See: Diagrams/Electrical Diagrams/Diagrams By Number

**Locations:** Location Views (reference numbers starting with 151-) referred to within these diagrams can be found at **Component Location Views**. See: Diagrams/Components/Component Location Views

**G109**

**PLEASE NOTE:** Some diagrams may appear to be missing because of gaps in the number sequences. These "gaps" are actually for diagrams that do not apply to the vehicle model selected.

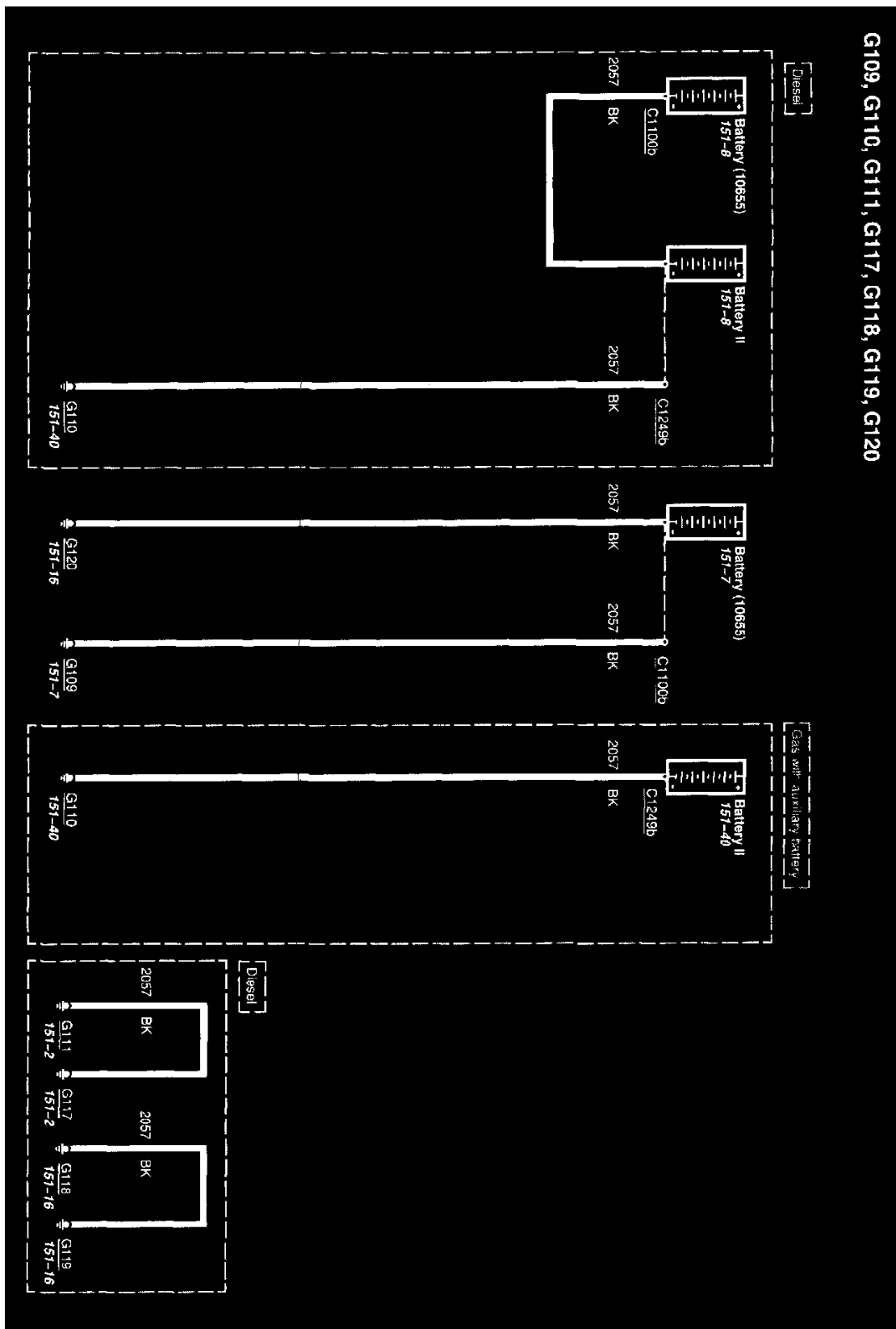

**Diagrams:** Other diagrams referred to by number (See Diagram #-#, etc.) within these diagrams can be found at **Diagrams By Number**. See: Diagrams/Electrical Diagrams/Diagrams By Number

**Locations:** Location Views (reference numbers starting with 151-) referred to within these diagrams can be found at **Component Location Views**. See: Diagrams/Components/Component Location Views

**G110**

**PLEASE NOTE:** Some diagrams may appear to be missing because of gaps in the number sequences. These "gaps" are actually for diagrams that do not apply to the vehicle model selected.

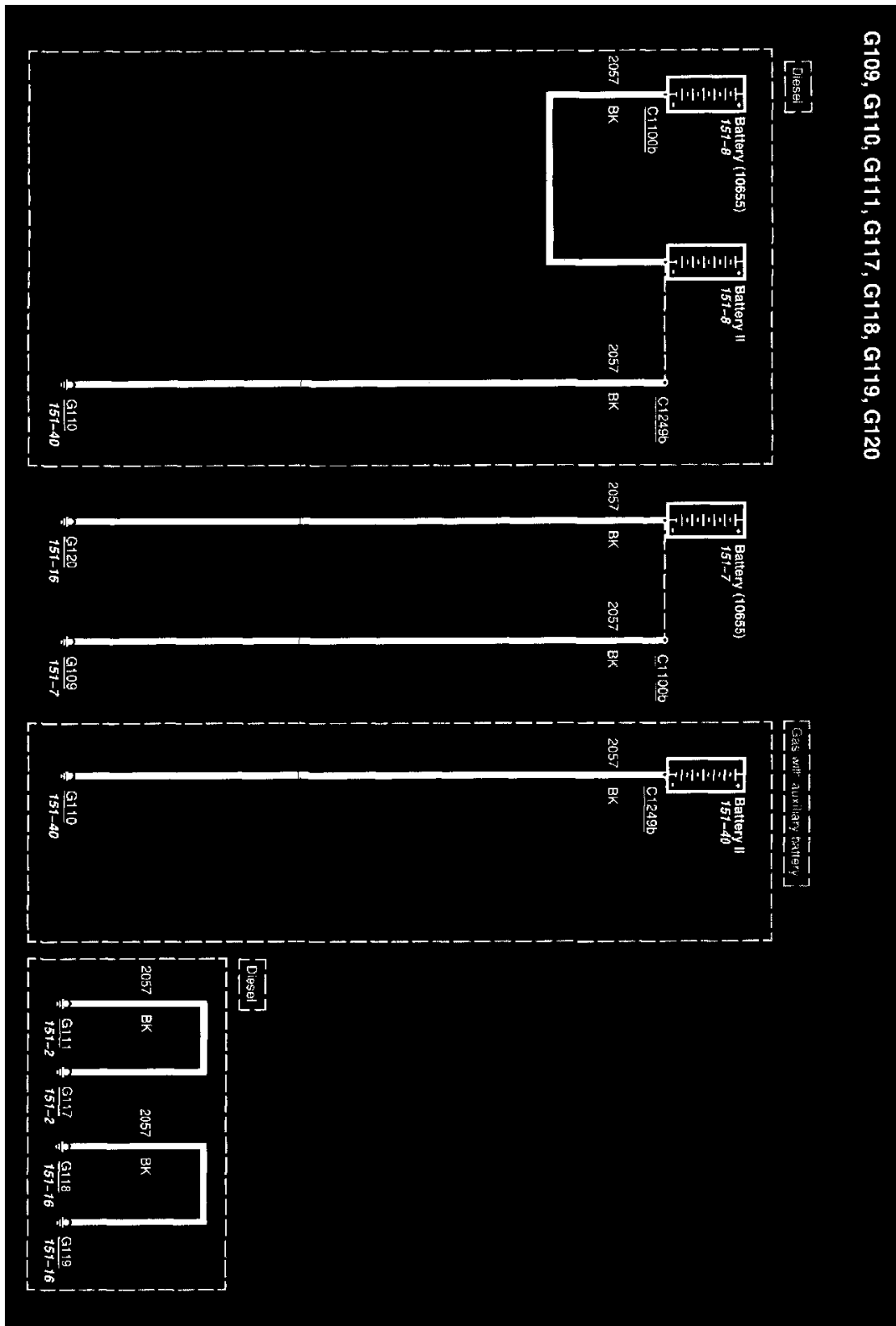

**Diagrams:** Other diagrams referred to by number (See Diagram #-#, etc.) within these diagrams can be found at **Diagrams By Number**. See: Diagrams/Electrical Diagrams/Diagrams By Number

**Locations:** Location Views (reference numbers starting with 151-) referred to within these diagrams can be found at **Component Location Views**. See: Diagrams/Components/Component Location Views

**G111**

**PLEASE NOTE:** Some diagrams may appear to be missing because of gaps in the number sequences. These "gaps" are actually for diagrams that do

not apply to the vehicle model selected.

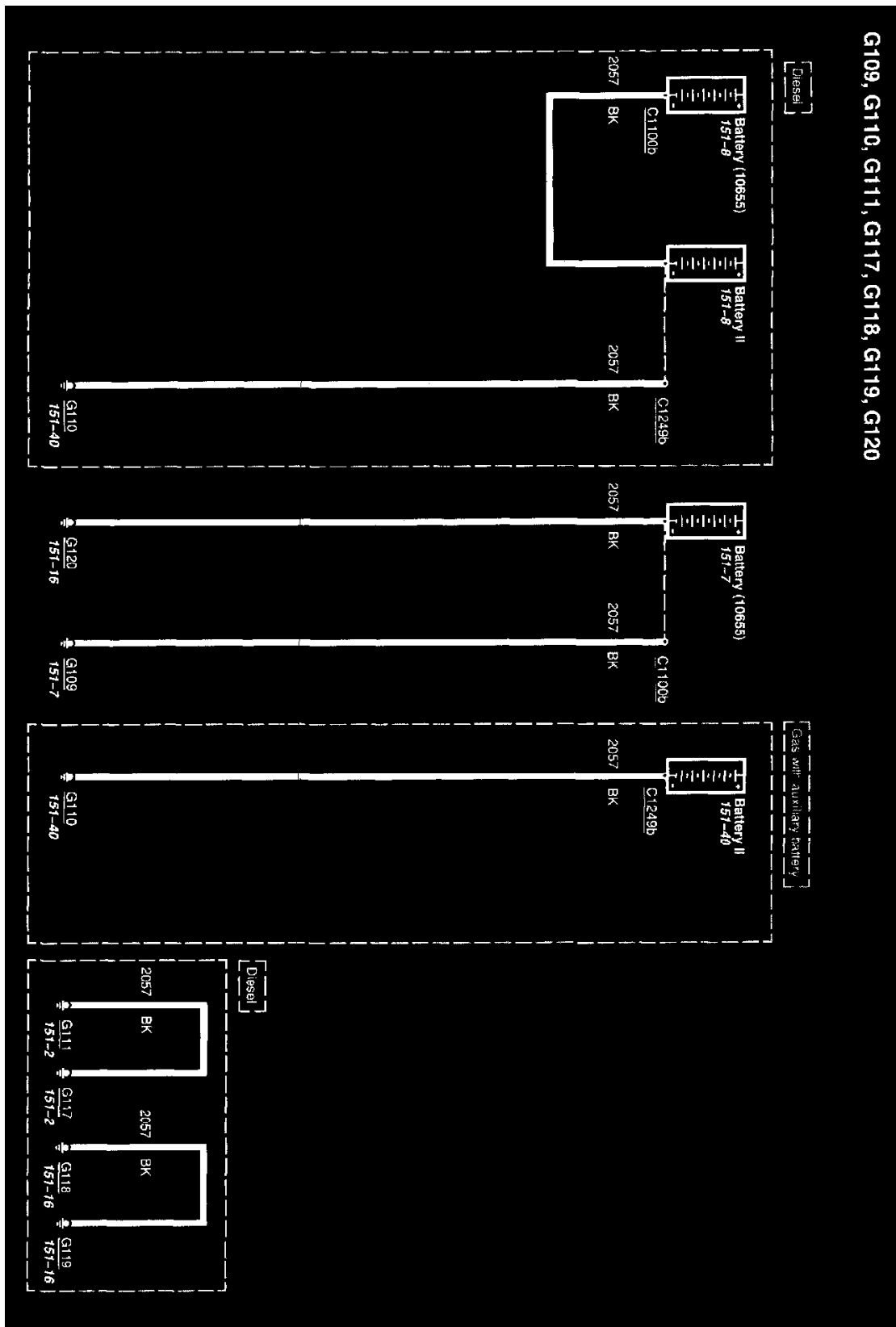

**Diagrams:** Other diagrams referred to by number (See Diagram #-#, etc.) within these diagrams can be found at **Diagrams By Number**. See: Diagrams/Electrical Diagrams/Diagrams By Number

**Locations:** Location Views (reference numbers starting with 151-) referred to within these diagrams can be found at **Component Location Views**. See: Diagrams/Components/Component Location Views

PLEASE NOTE: Some diagrams may appear to be missing because of gaps in the number sequences. These "gaps" are actually for diagrams that do not apply to the vehicle model selected.

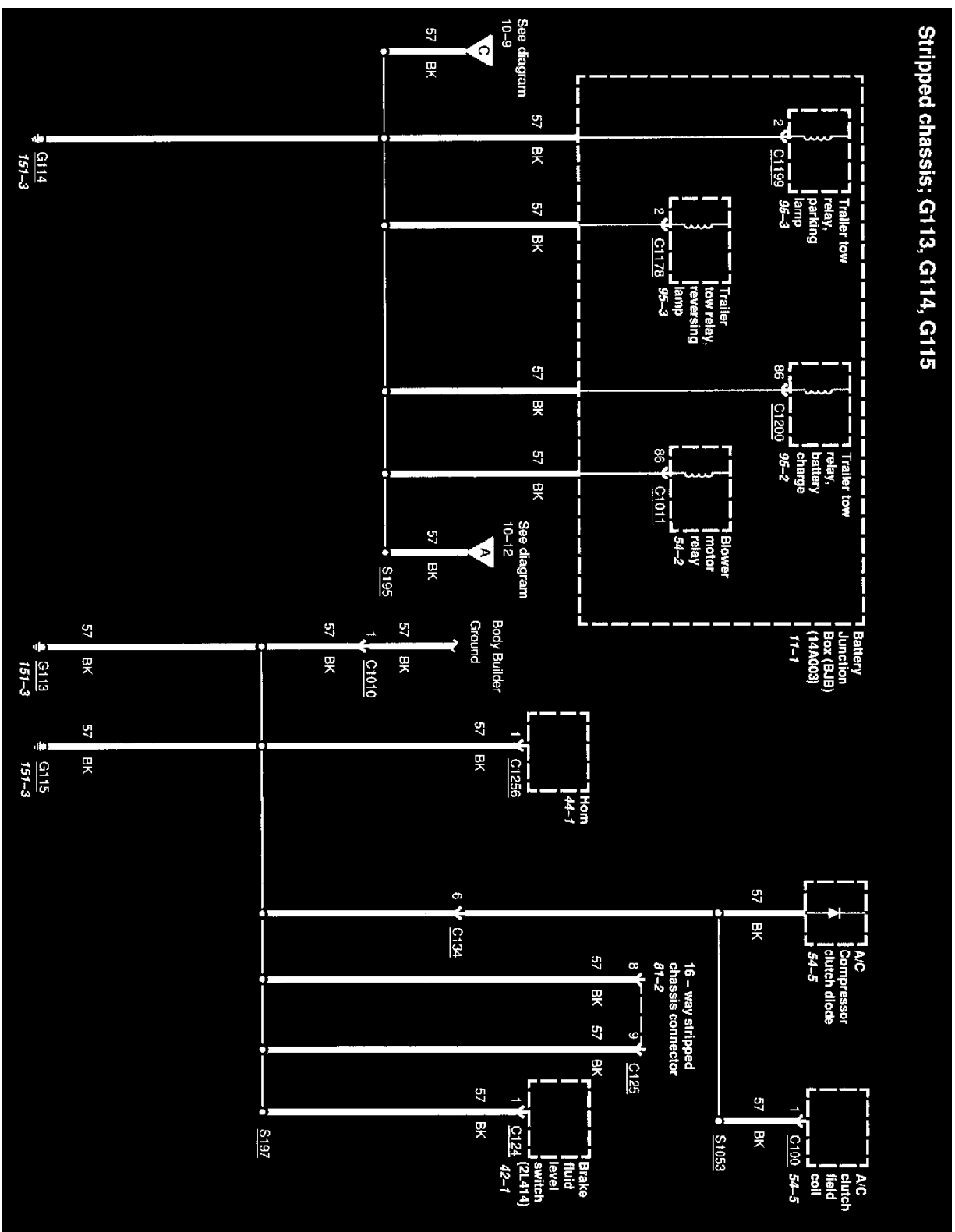



Stripped chassis; G113, G114, G115

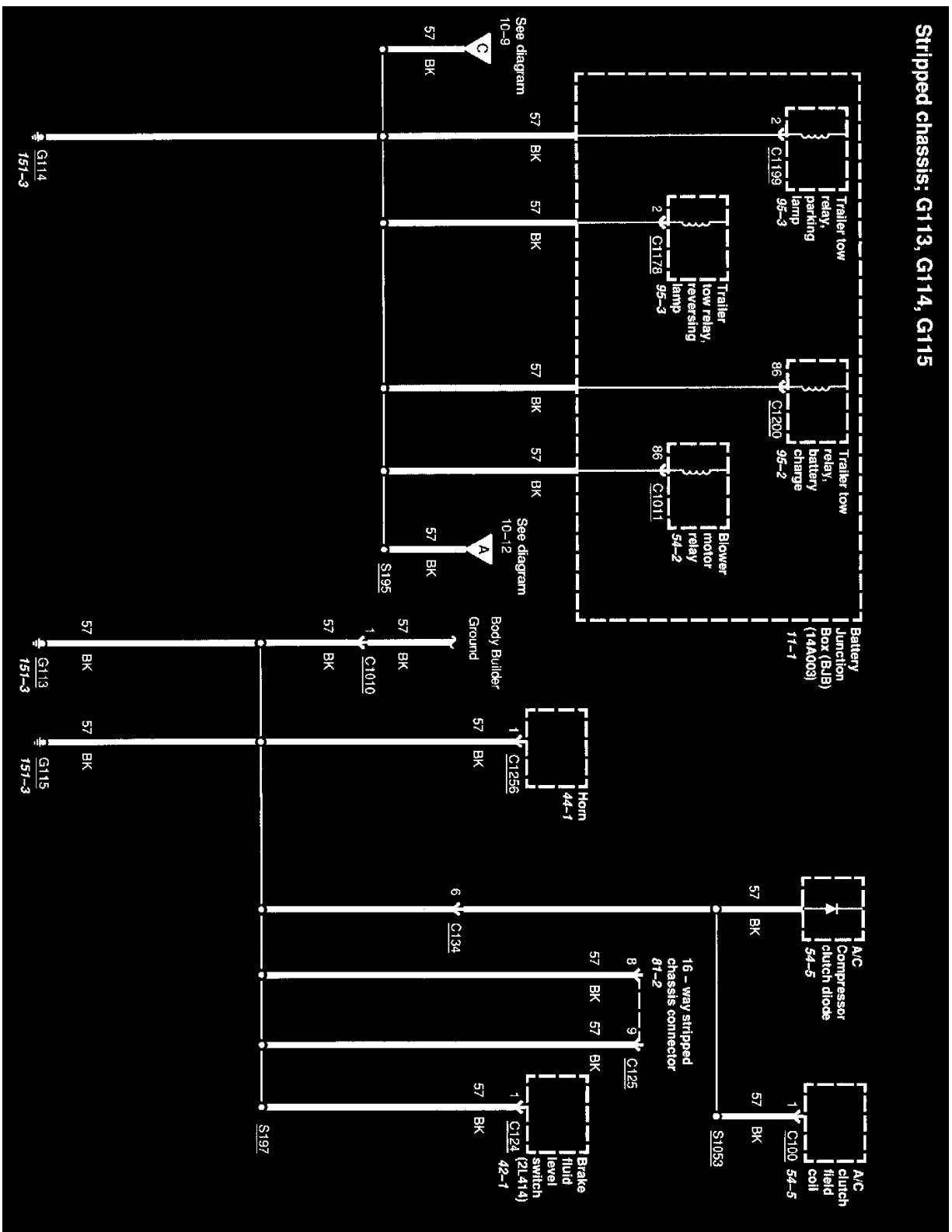



Stripped chassis; G113, G114, G115

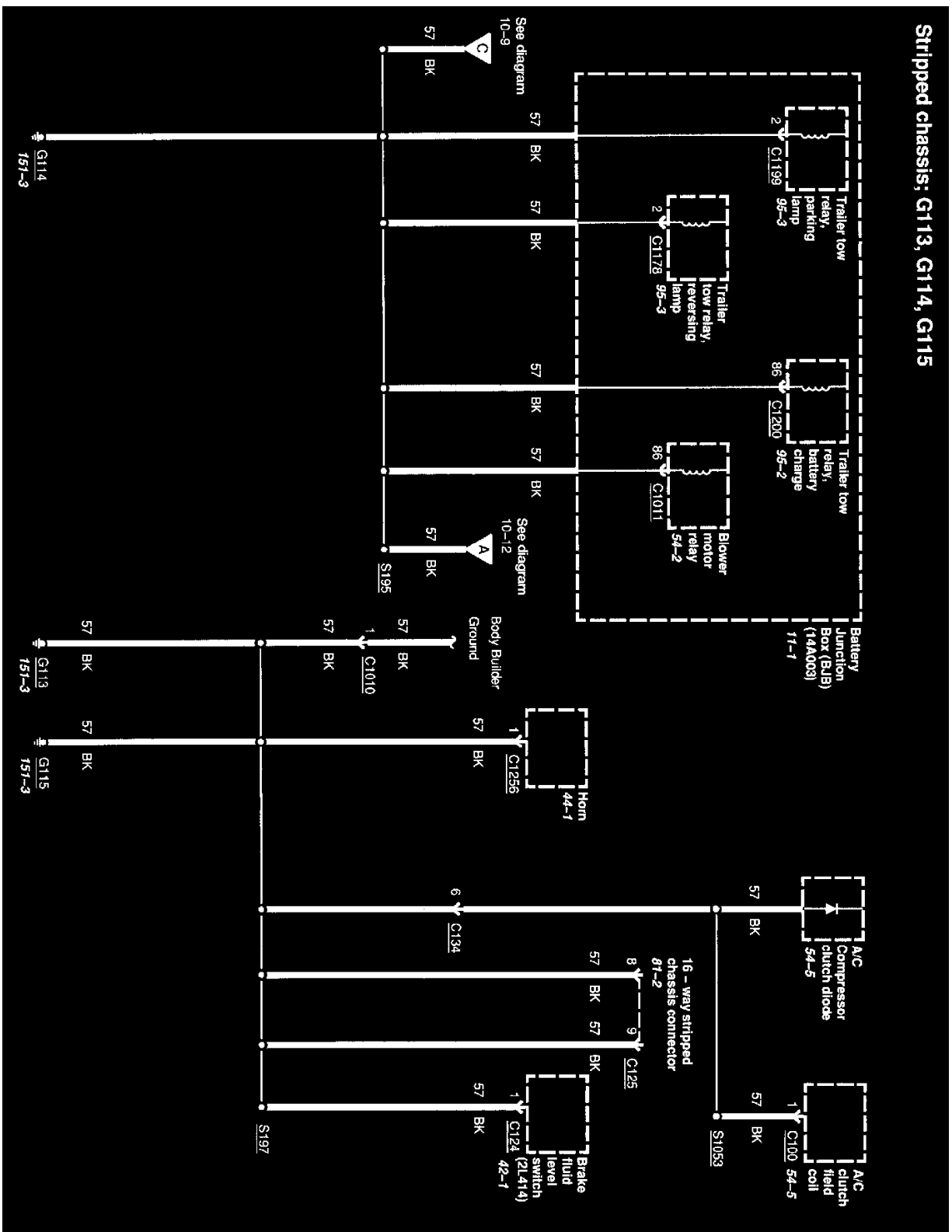



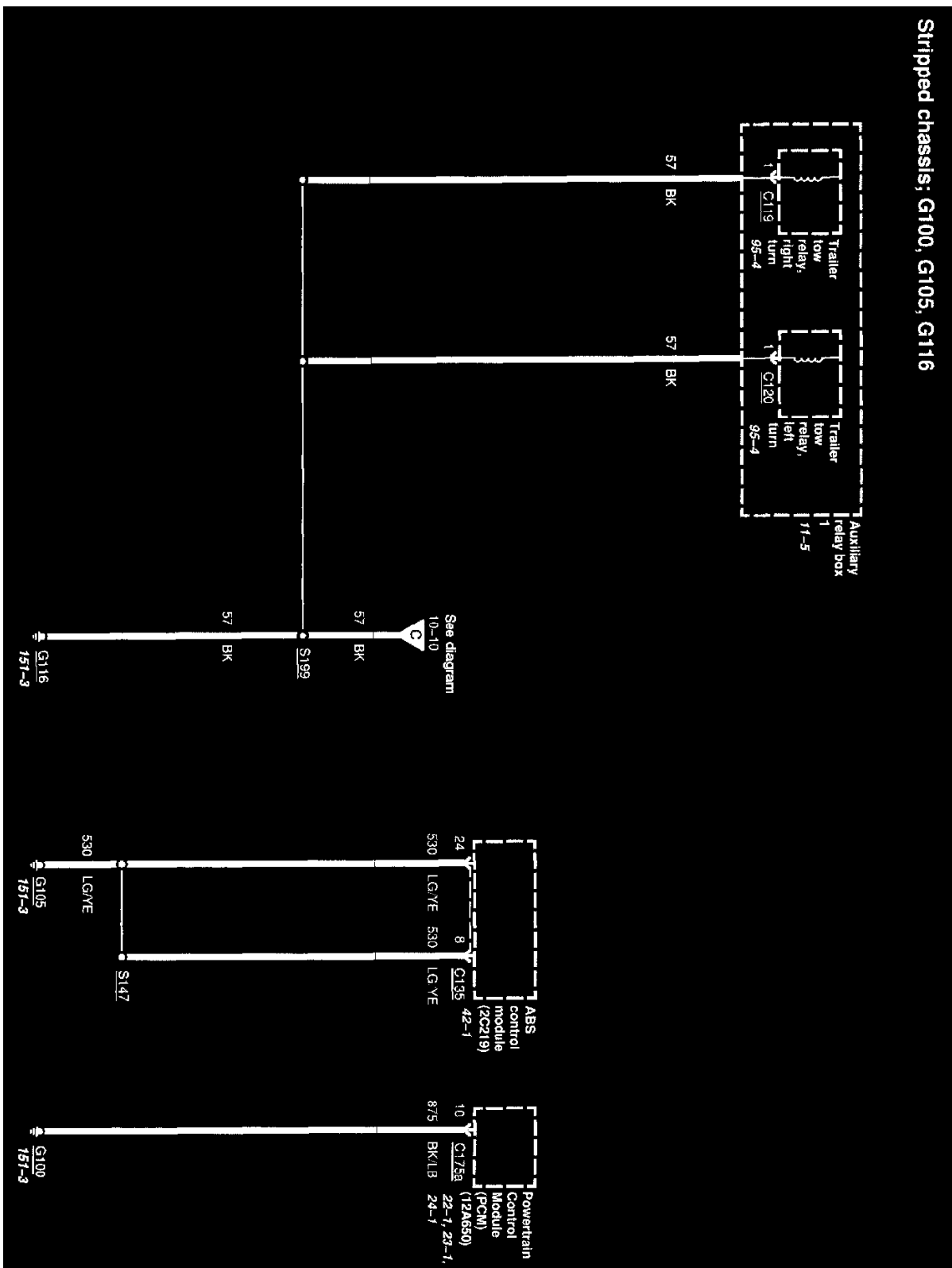

**Diagrams:** Other diagrams referred to by number (See Diagram #-#, etc.) within these diagrams can be found at **Diagrams By Number**. See: Diagrams/Electrical Diagrams/Diagrams By Number

**Locations:** Location Views (reference numbers starting with 151-) referred to within these diagrams can be found at **Component Location Views**. See: Diagrams/Components/Component Location Views

**G117**

**PLEASE NOTE:** Some diagrams may appear to be missing because of gaps in the number sequences. These "gaps" are actually for diagrams that do not apply to the vehicle model selected.

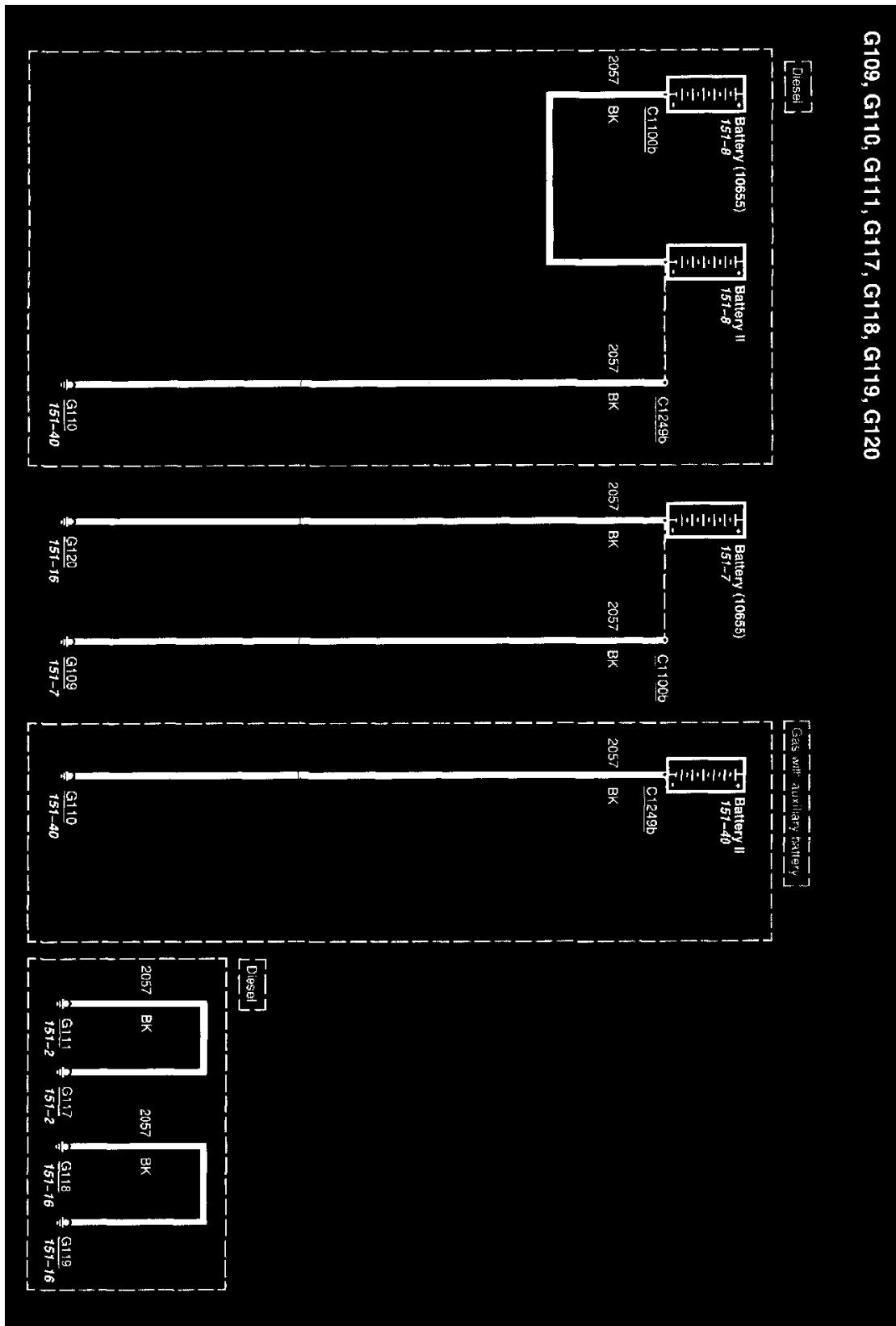

**Diagrams:** Other diagrams referred to by number (See Diagram #-#, etc.) within these diagrams can be found at **Diagrams By Number**. See: Diagrams/Electrical Diagrams/Diagrams By Number

**Locations:** Location Views (reference numbers starting with 151-) referred to within these diagrams can be found at **Component Location Views**. See: Diagrams/Components/Component Location Views

**G118**

**PLEASE NOTE:** Some diagrams may appear to be missing because of gaps in the number sequences. These "gaps" are actually for diagrams that do

not apply to the vehicle model selected.

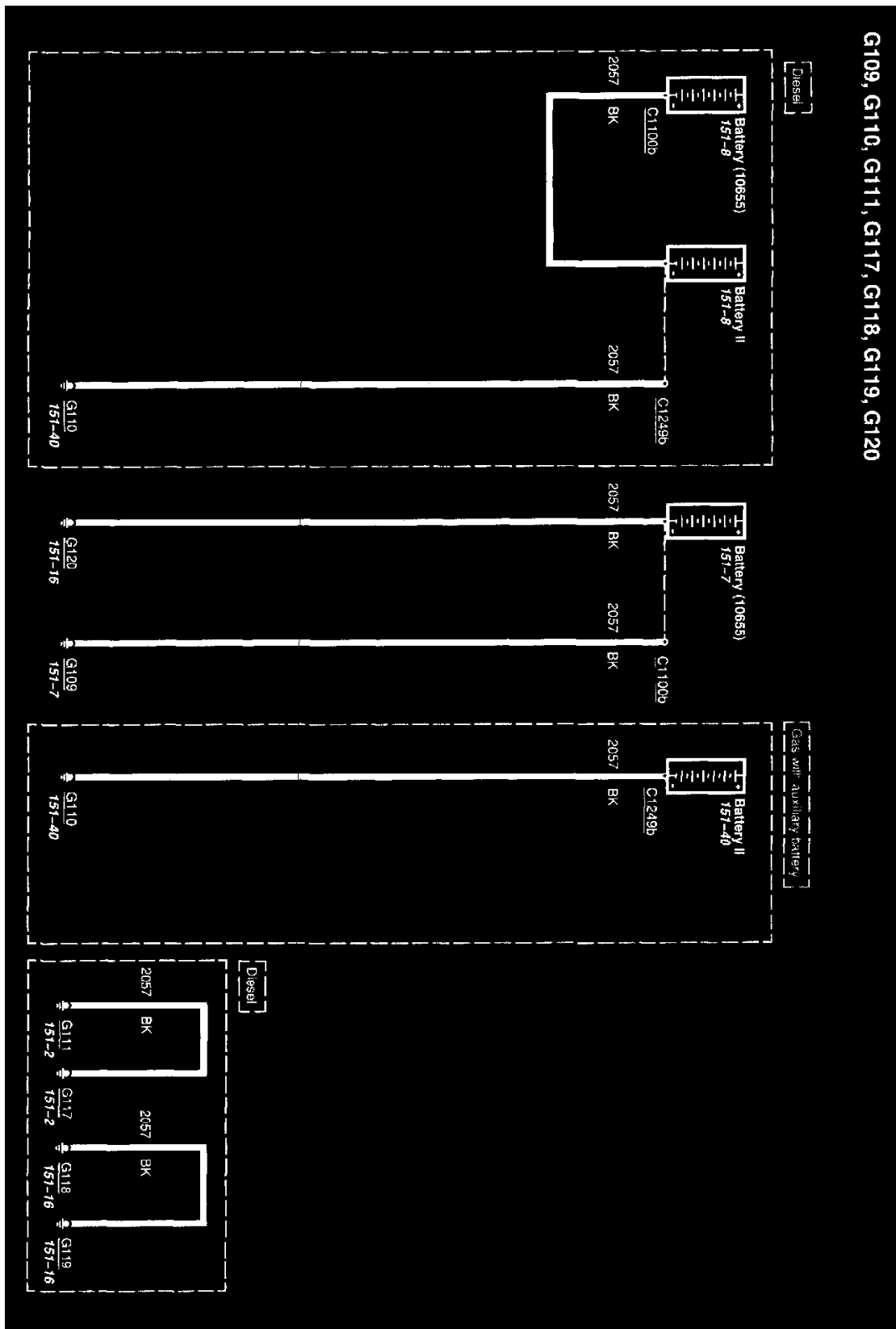

**Diagrams:** Other diagrams referred to by number (See Diagram #-#, etc.) within these diagrams can be found at **Diagrams By Number**. See: Diagrams/Electrical Diagrams/Diagrams By Number

**Locations:** Location Views (reference numbers starting with 151-) referred to within these diagrams can be found at **Component Location Views**. See: Diagrams/Components/Component Location Views

**PLEASE NOTE:** Some diagrams may appear to be missing because of gaps in the number sequences. These "gaps" are actually for diagrams that do not apply to the vehicle model selected.

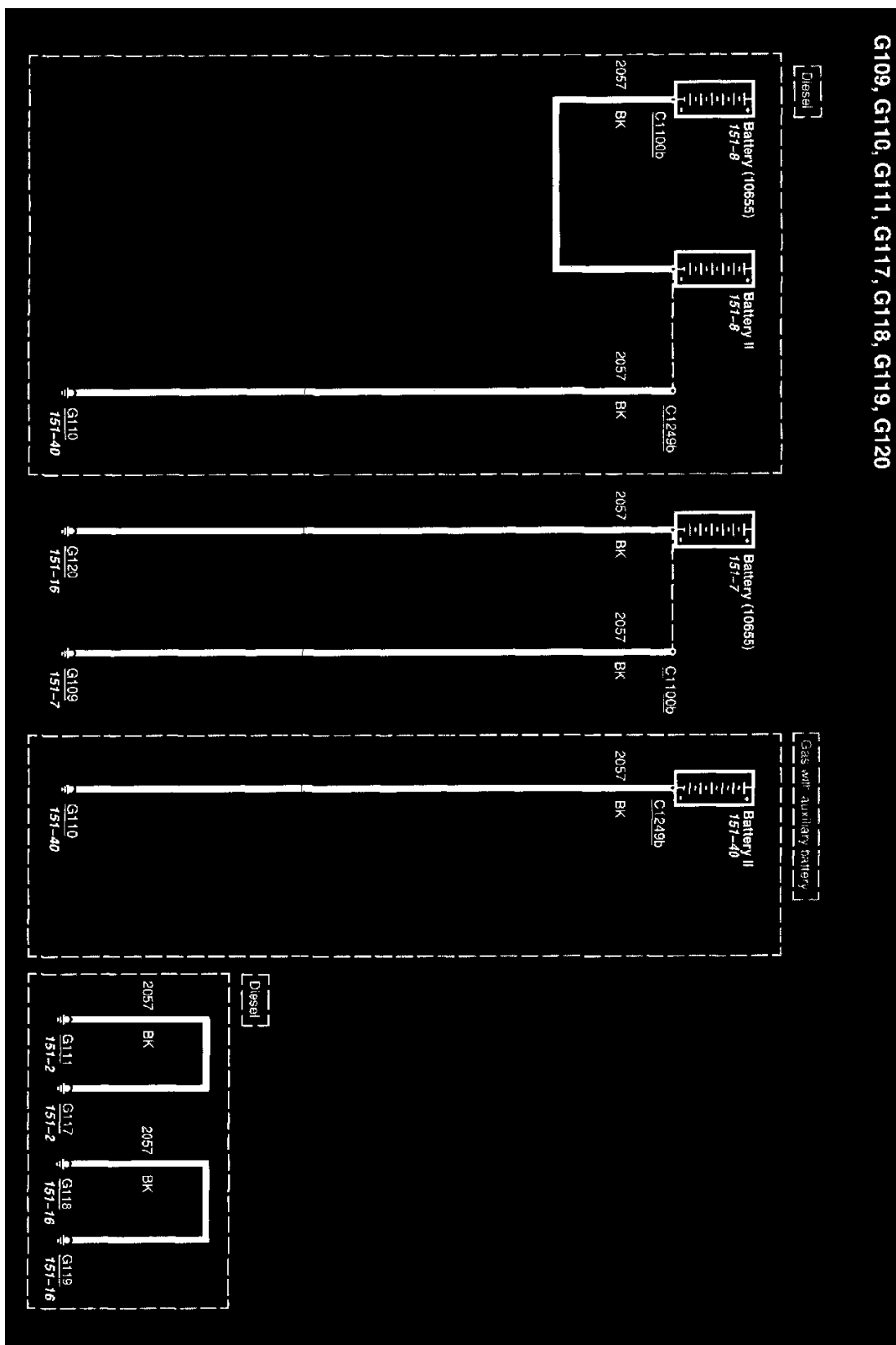

**Diagrams:** Other diagrams referred to by number (See Diagram #-#, etc.) within these diagrams can be found at **Diagrams By Number**. See: Diagrams/Electrical Diagrams/Diagrams By Number

**Locations:** Location Views (reference numbers starting with 151-) referred to within these diagrams can be found at **Component Location Views**. See: Diagrams/Components/Component Location Views

### G120

**PLEASE NOTE:** Some diagrams may appear to be missing because of gaps in the number sequences. These "gaps" are actually for diagrams that do not apply to the vehicle model selected.

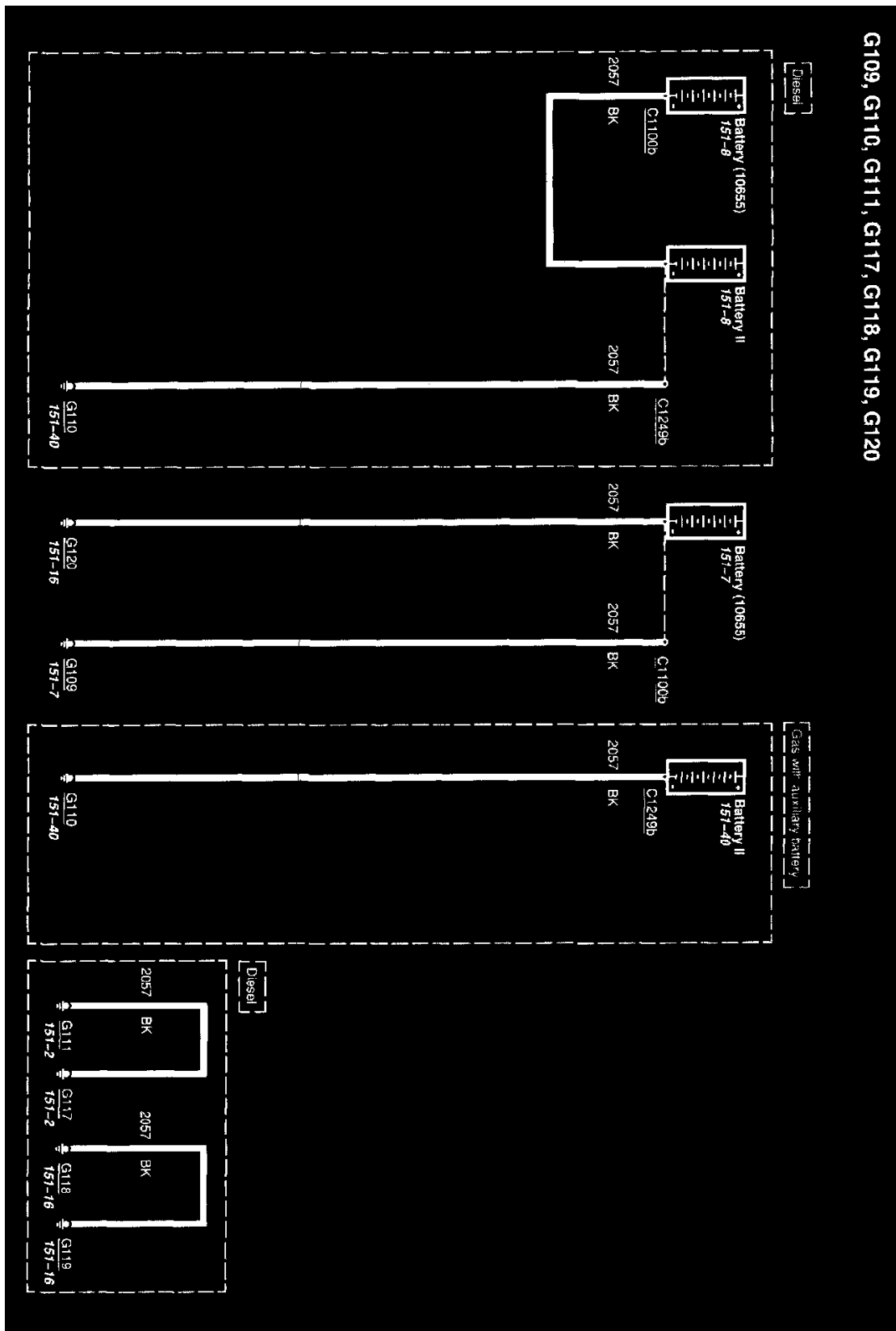

**Diagrams:** Other diagrams referred to by number (See Diagram ##-#, etc.) within these diagrams can be found at **Diagrams By Number**. See: **Diagrams/Electrical Diagrams/Diagrams By Number**

**Locations:** Location Views (reference numbers starting with 151-) referred to within these diagrams can be found at **Component Location Views**.

See: Diagrams/Components/Component Location Views

### G200

**PLEASE NOTE:** Some diagrams may appear to be missing because of gaps in the number sequences. These "gaps" are actually for diagrams that do not apply to the vehicle model selected.

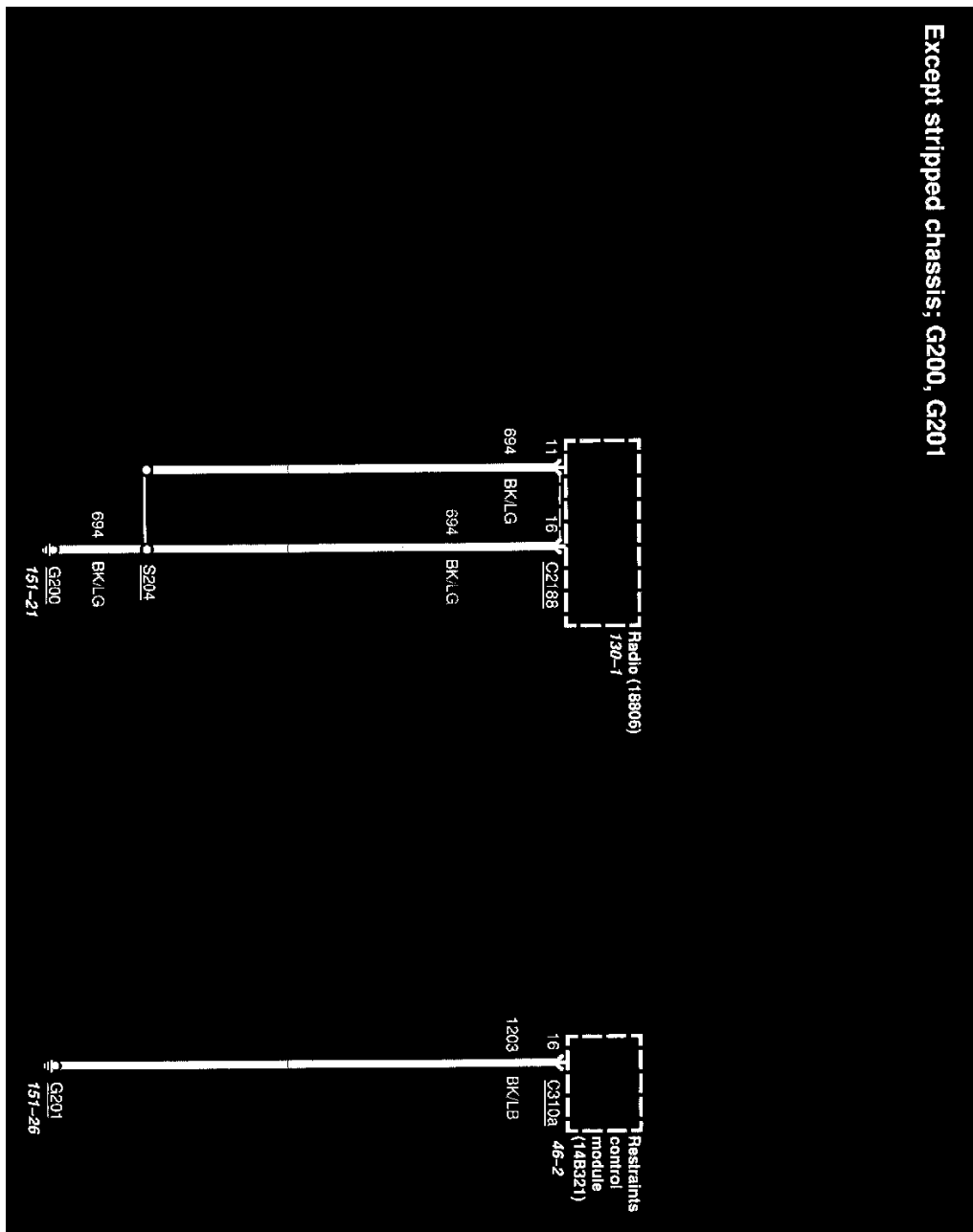

10-13

**Diagrams:** Other diagrams referred to by number (See Diagram #-#, etc.) within these diagrams can be found at **Diagrams By Number**. See: Diagrams/Electrical Diagrams/Diagrams By Number

**Locations:** Location Views (reference numbers starting with 151-) referred to within these diagrams can be found at **Component Location Views**. See: Diagrams/Components/Component Location Views

### G201

**PLEASE NOTE:** Some diagrams may appear to be missing because of gaps in the number sequences. These "gaps" are actually for diagrams that do not apply to the vehicle model selected.

Except stripped chassis; G200, G201

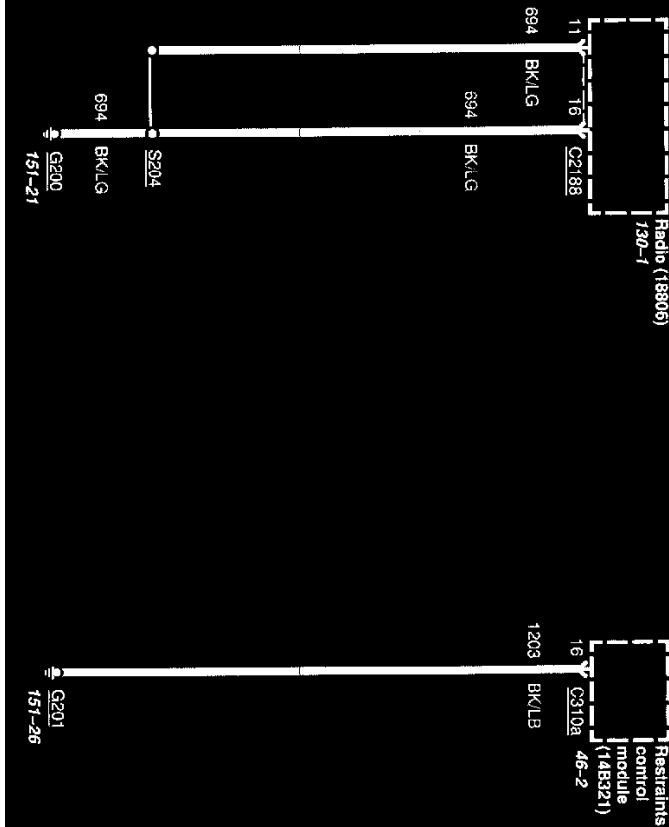

10-13

**Diagrams:** Other diagrams referred to by number (See Diagram #-#, etc.) within these diagrams can be found at **Diagrams By Number**. See: Diagrams/Electrical Diagrams/Diagrams By Number

**Locations:** Location Views (reference numbers starting with 151-) referred to within these diagrams can be found at **Component Location Views**. See: Diagrams/Components/Component Location Views

## G202

**PLEASE NOTE:** Some diagrams may appear to be missing because of gaps in the number sequences. These "gaps" are actually for diagrams that do not apply to the vehicle model selected.

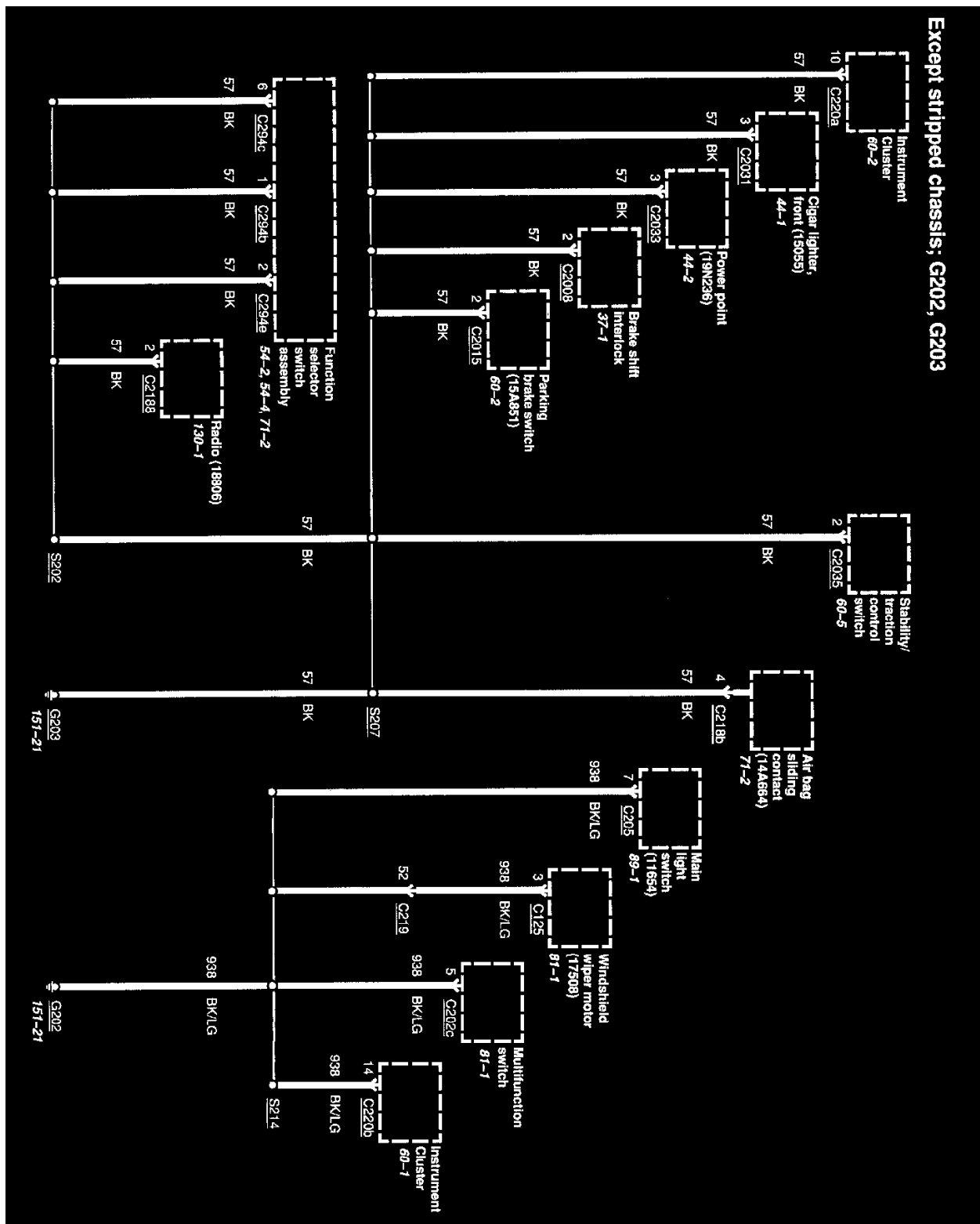

10-18

**Diagrams:** Other diagrams referred to by number (See Diagram #-#, etc.) within these diagrams can be found at **Diagrams By Number**. See: Diagrams/Electrical Diagrams/Diagrams By Number

**Locations:** Location Views (reference numbers starting with 151-) referred to within these diagrams can be found at **Component Location Views**. See: Diagrams/Components/Component Location Views

**G203**

**PLEASE NOTE:** Some diagrams may appear to be missing because of gaps in the number sequences. These "gaps" are actually for diagrams that do not apply to the vehicle model selected.

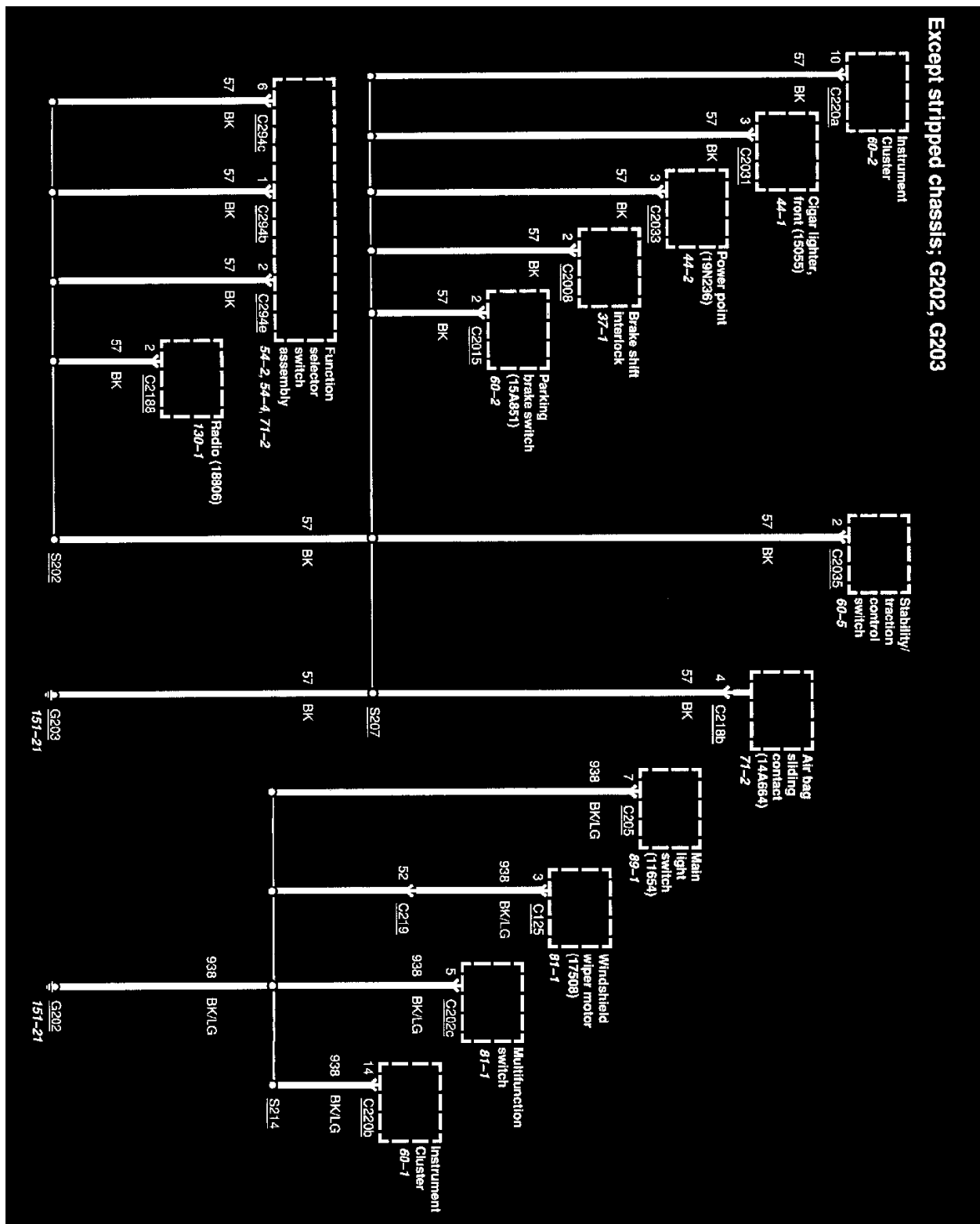

10-18

**Diagrams:** Other diagrams referred to by number (See Diagram #-#, etc.) within these diagrams can be found at **Diagrams By Number**. See: **Diagrams/Electrical Diagrams/Diagrams By Number**

**Locations:** Location Views (reference numbers starting with 151-) referred to within these diagrams can be found at **Component Location Views**. See: **Diagrams/Components/Component Location Views**

**G204**

**PLEASE NOTE:** Some diagrams may appear to be missing because of gaps in the number sequences. These "gaps" are actually for diagrams that do not apply to the vehicle model selected.

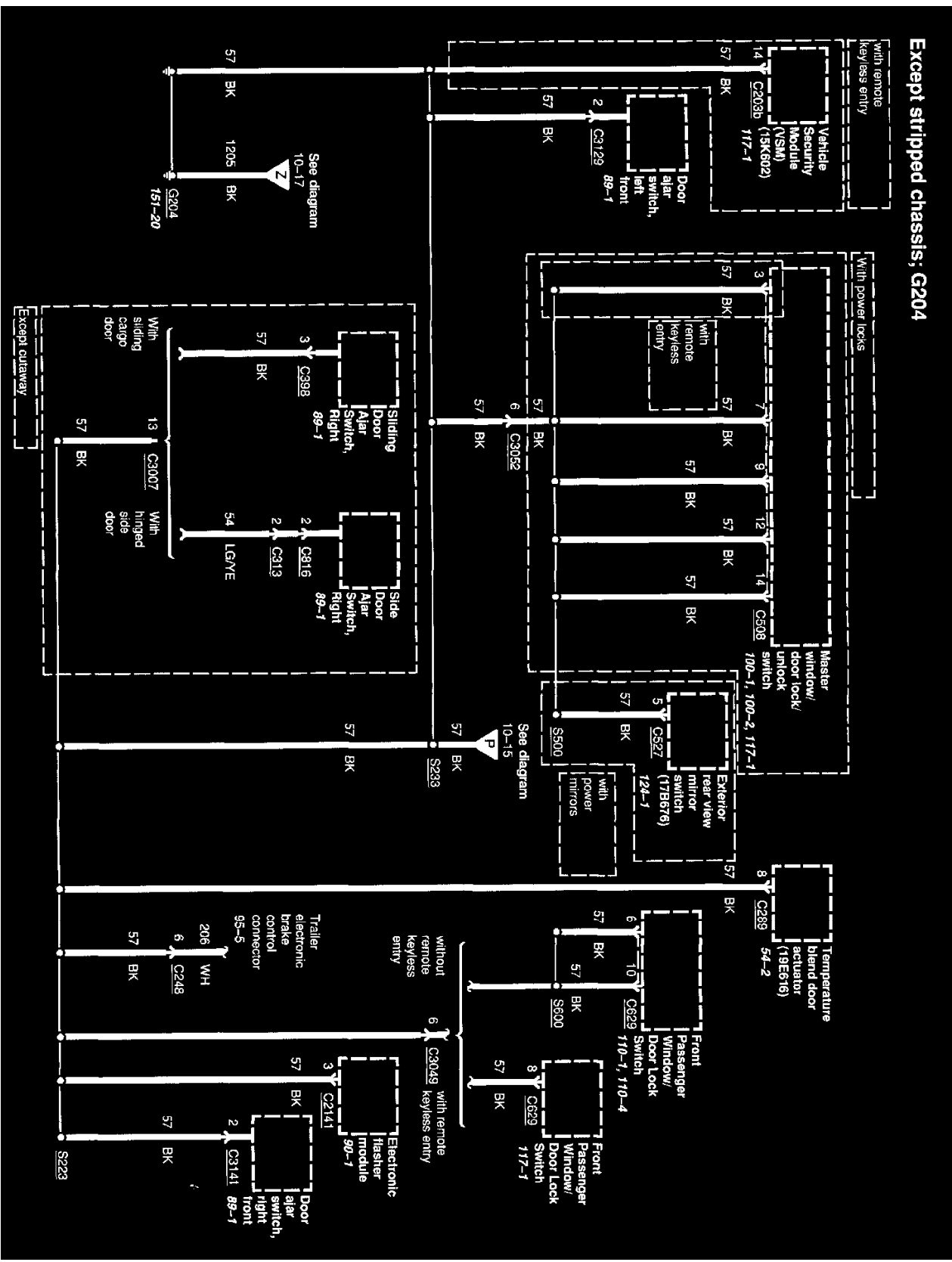



Except stripped chassis

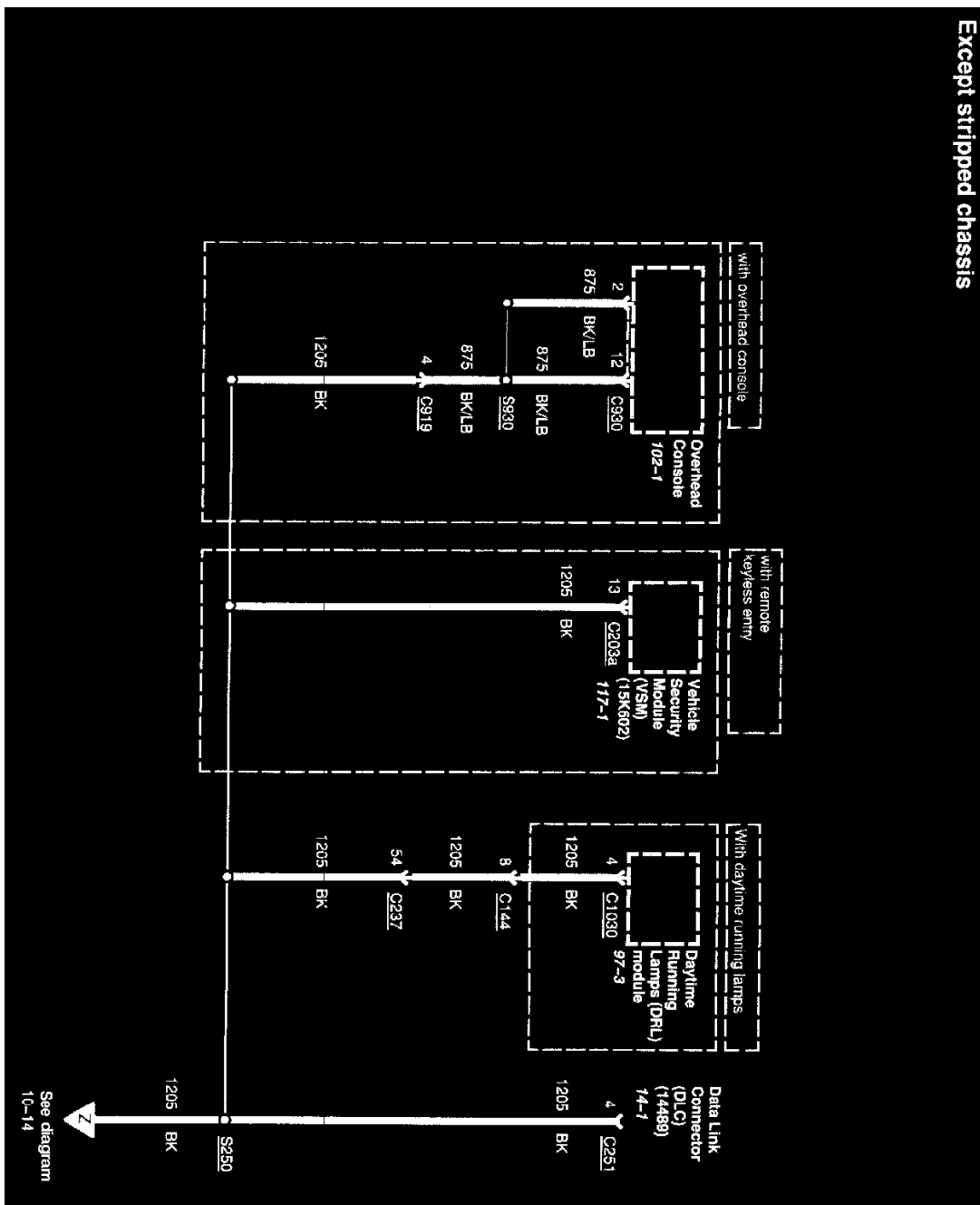

10-17

**Diagrams:** Other diagrams referred to by number (See Diagram #-#, etc.) within these diagrams can be found at **Diagrams By Number**. See: Diagrams/Electrical Diagrams/Diagrams By Number

**Locations:** Location Views (reference numbers starting with 151-) referred to within these diagrams can be found at **Component Location Views**. See: Diagrams/Components/Component Location Views

**G207**

**PLEASE NOTE:** Some diagrams may appear to be missing because of gaps in the number sequences. These "gaps" are actually for diagrams that do not apply to the vehicle model selected.





### G300

**PLEASE NOTE:** Some diagrams may appear to be missing because of gaps in the number sequences. These "gaps" are actually for diagrams that do not apply to the vehicle model selected.

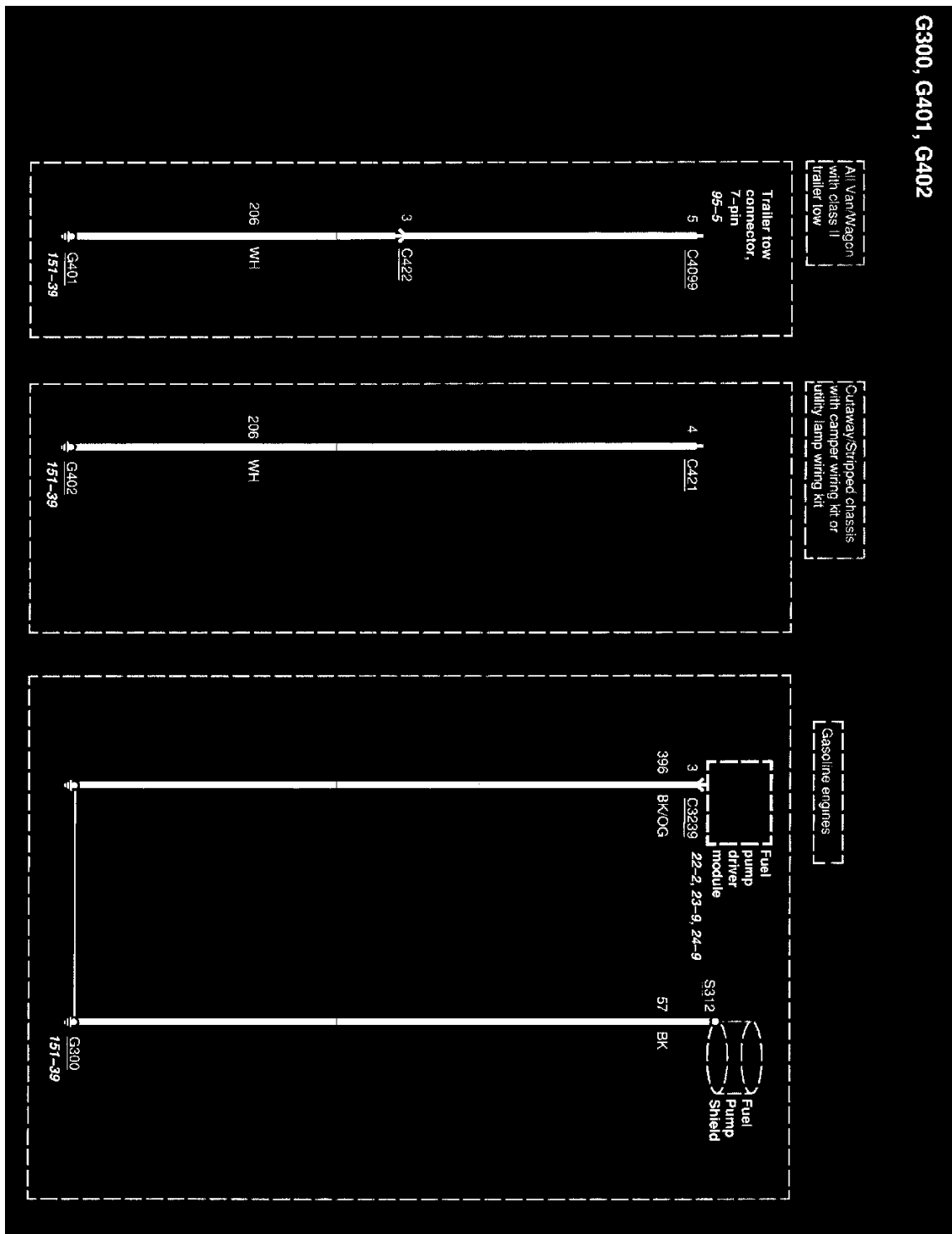

**Diagrams:** Other diagrams referred to by number (See Diagram ##-#, etc.) within these diagrams can be found at **Diagrams By Number**. See: Diagrams/Electrical Diagrams/Diagrams By Number

**Locations:** Location Views (reference numbers starting with 151-) referred to within these diagrams can be found at **Component Location Views**. See: Diagrams/Components/Component Location Views

### G400

**PLEASE NOTE:** Some diagrams may appear to be missing because of gaps in the number sequences. These "gaps" are actually for diagrams that do not apply to the vehicle model selected.

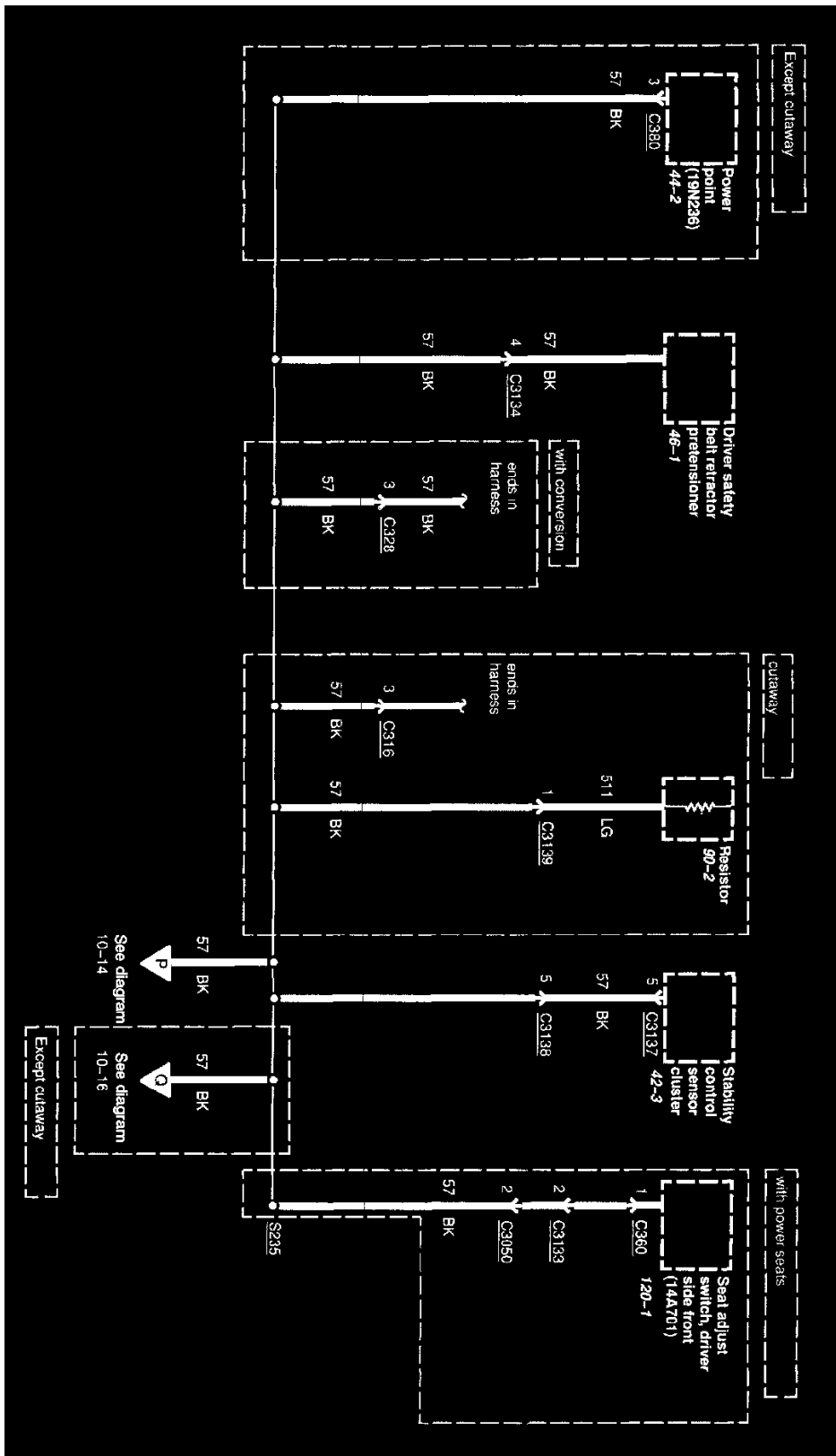

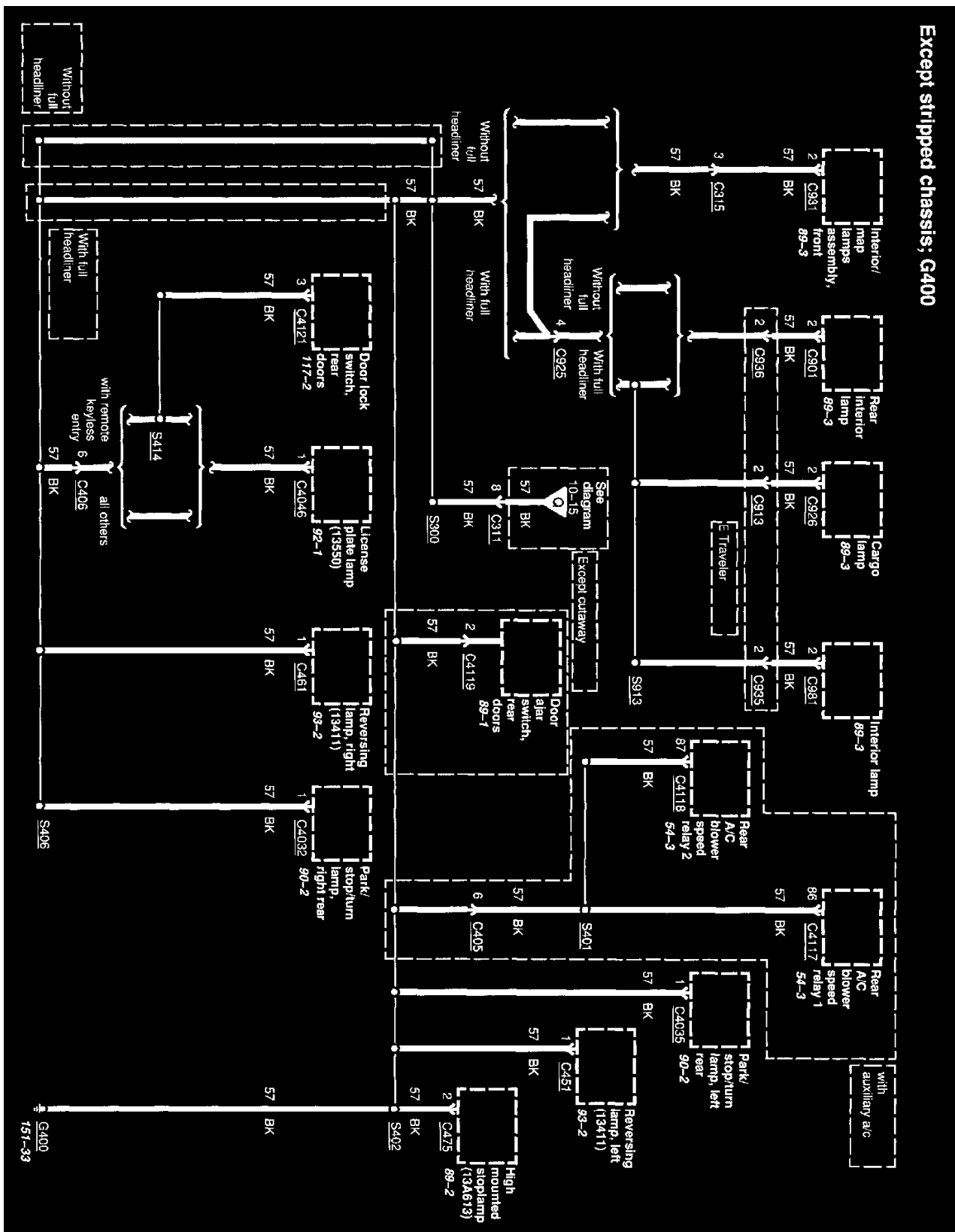

Except stripped chassis: G400

10-16

**Diagrams:** Other diagrams referred to by number (See Diagram #-#, etc.) within these diagrams can be found at **Diagrams By Number**. See: **Diagrams/Electrical Diagrams/Diagrams By Number**

**Locations:** Location Views (reference numbers starting with 151-) referred to within these diagrams can be found at **Component Location Views**. See: **Diagrams/Components/Component Location Views**

**G401**

**PLEASE NOTE:** Some diagrams may appear to be missing because of gaps in the number sequences. These "gaps" are actually for diagrams that do not apply to the vehicle model selected.

**G300, G401, G402**

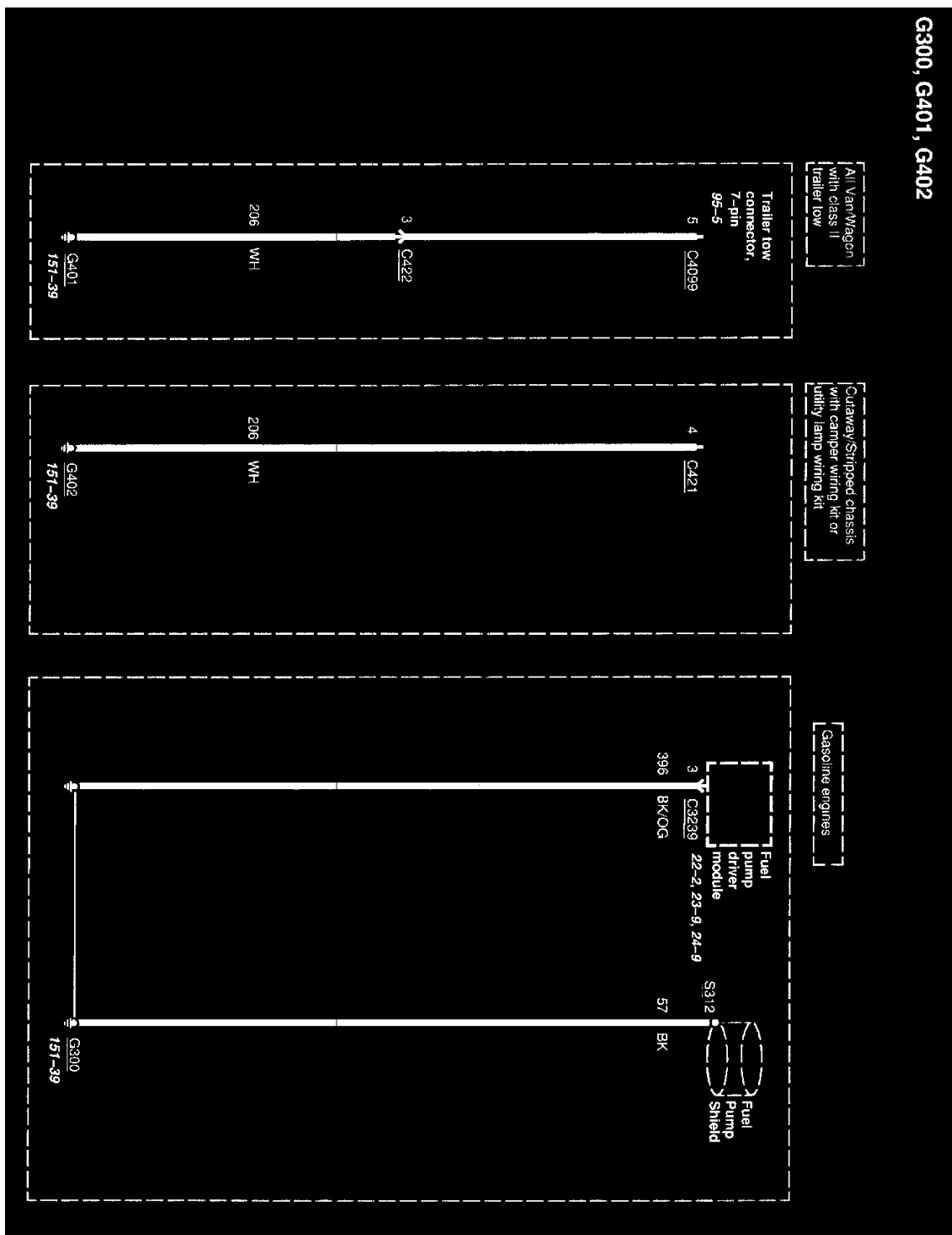

**Diagrams:** Other diagrams referred to by number (See Diagram #-#, etc.) within these diagrams can be found at **Diagrams By Number**. See: Diagrams/Electrical Diagrams/Diagrams By Number

**Locations:** Location Views (reference numbers starting with 151-) referred to within these diagrams can be found at **Component Location Views**. See: Diagrams/Components/Component Location Views

**G402**

**PLEASE NOTE:** Some diagrams may appear to be missing because of gaps in the number sequences. These "gaps" are actually for diagrams that do not apply to the vehicle model selected.

